

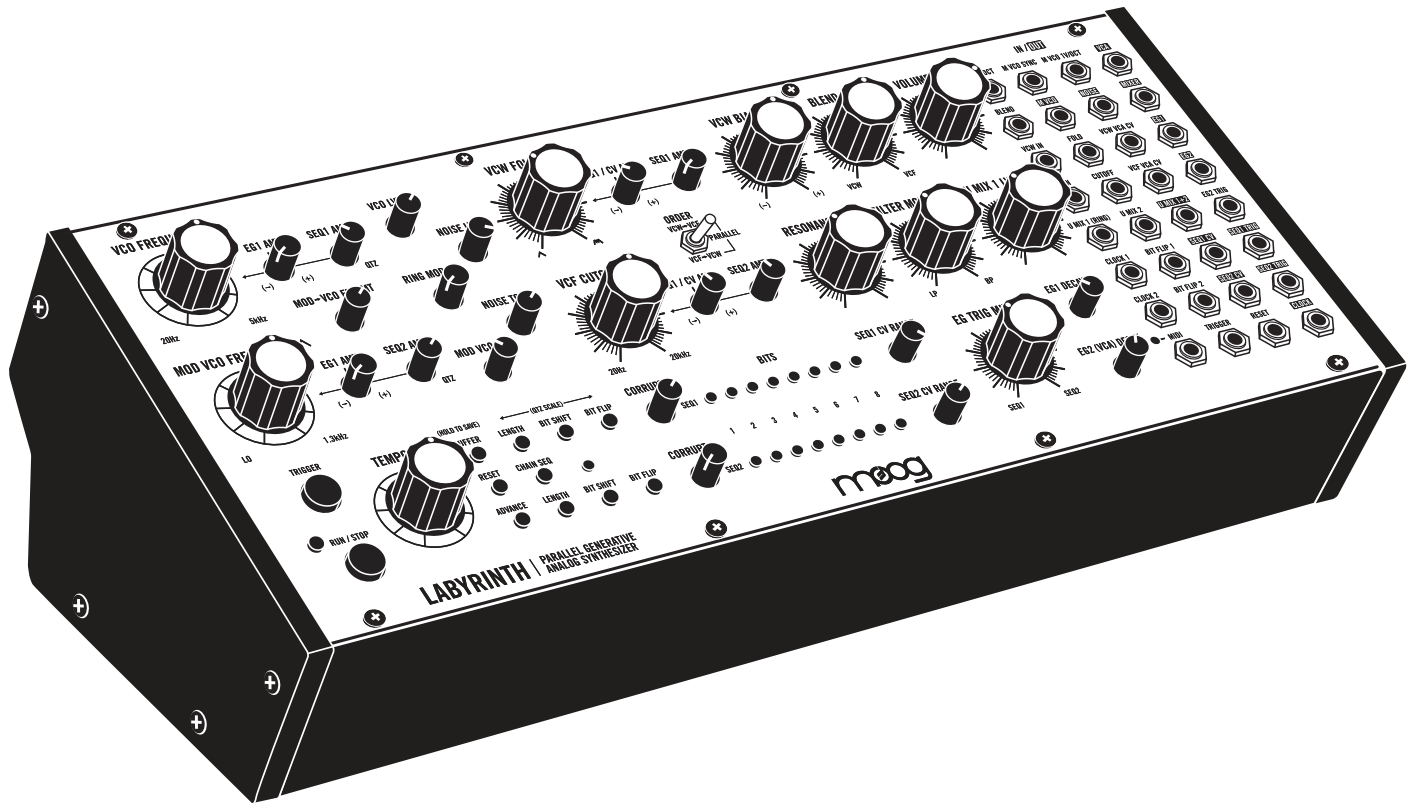

LABYRINTH

USER'S MANUAL



“What artists need is an endless resource,
full of rough edges and dimly lit nooks and
crannies that one can explore as one sees fit.”

- Dr. Robert Moog -

IMPORTANT SAFETY INSTRUCTIONS

WARNING: WHEN USING ELECTRIC PRODUCTS, THESE BASIC PRECAUTIONS SHOULD ALWAYS BE FOLLOWED.

1. Read all the instructions before using the product.
2. Do not use apparatus near water—for example, but not limited to, near a bathtub, washbowl, or kitchen sink; in a wet basement; or near a swimming pool.
3. This product, in combination with an amplifier and headphones or speakers, may be capable of producing sound levels that could cause permanent hearing loss. Do not operate for a long period of time at a high volume level or at a level that is uncomfortable.
4. The product should be located so that its location does not interfere with its proper ventilation.
5. The product should be located away from heat sources such as radiators, heat registers, or other products that produce heat. No naked flame sources (such as candles, lighters, etc.) should be placed near this product.
6. Do not operate in direct sunlight.
7. The product should be connected to a power supply only of the type described in the operating instructions or as marked on the product.
8. The power supply cord of the product should be unplugged from the outlet when left unused for a long period of time or during lightning storms.
9. Care should be taken so that objects do not fall, and liquids are not spilled, into the enclosure through openings.

There are no user serviceable parts inside. Refer all servicing to qualified personnel only.

NOTE: This equipment has been tested and found to comply with the limits for a Class B digital device, pursuant to Part 15 of the FCC rules. These limits are designed to provide reasonable protection against harmful interference in a residential installation. This equipment generates, uses, and can radiate radio frequency energy and, if not installed and used in accordance with the instructions, may cause harmful interference to radio communications. However, there is no guarantee that interference will not occur in a particular installation. If this equipment does cause harmful interference to radio or television reception, which can be determined by turning the equipment off and on, the user is encouraged to try to correct the interference by one or more of the following measures:

- Reorient or relocate the receiving antenna.
- Increase the separation between the equipment and receiver.
- Connect the equipment to an outlet on a circuit different from that to which the receiver is connected.
- Consult the dealer or an experienced radio/TV technician for help.

CAUTION: Please note that any changes or modifications made to this product not expressly approved by Moog Music, Inc. could void the user's authority granted by the FCC to operate the equipment.

TABLE OF CONTENTS

6 UNPACKING AND INSPECTION

6 SETUP AND CONNECTIONS

7 LABYRINTH OVERVIEW

7 ABOUT LABYRINTH

10 PARALLEL VOICES

11 DUAL GENERATIVE SEQUENCERS

12 EXPLORING LABYRINTH

25 PANEL CONTROLS & FUNCTIONS

25 THE OSCILLATORS

27 THE MIXER

28 THE WAVEFOLDER

30 THE FILTER

32 THE BLEND/AMPLIFIERS

34 ENVELOPE GENERATORS

35 SEQUENCER TRANSPORT CONTROLS

37 SEQUENCER BUTTON COMBOS

38 SEQUENCER QUANTIZATION MODES

46 GLOBAL SETTINGS

47 MIDI OPERATIONS

48 PRESETS

54 SIGNAL FLOW

56 SPECIFICATIONS

57 WARRANTY

57 SERVICE AND SUPPORT INFORMATION

UNPACKING AND INSPECTION

Check the contents of the shipping carton. Be careful when unpacking your new Moog Labyrinth so that nothing is lost or damaged. We recommend saving the carton and all packing materials in case you ever need to ship the instrument for any reason.

Labyrinth ships with the following items:

1. Labyrinth Parallel Generative Analog Synthesizer
2. Power Supply
3. Patch Sheet Overlays
4. Owner's Manual
5. Patch Cables
6. Registration Card

What you will need:

1. Headphones with a 1/4" TRS plug, or a 1/4" TS instrument cable and an amplified speaker
2. A properly wired AC outlet

SETUP AND CONNECTIONS

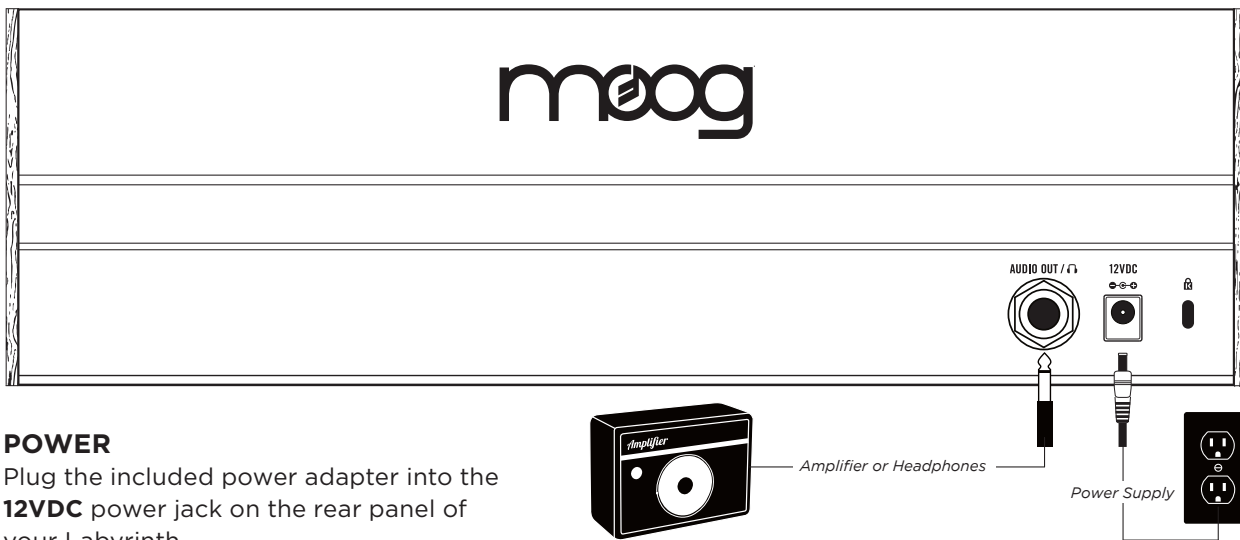

POWER

Plug the included power adapter into the **12VDC** power jack on the rear panel of your Labyrinth.

NOTE: There is no power switch on your Labyrinth. Once connected to the power supply, the unit is on. Labyrinth is an analog instrument and should be allowed a few minutes to warm up before use. In cases where it has been left in a cold car overnight, for example, it may take even longer for the oscillator tuning to stabilize. For optimized tuning do not operate your Labyrinth in direct sunlight.

AUDIO OUT/ \square

With the Labyrinth **VOLUME** knob turned all the way down (counterclockwise), plug one end of a 1/4" instrument cable into the Labyrinth **AUDIO OUT/ \square** jack on the rear panel. Then plug the other end into an amplified speaker or mixing console input. This jack can also be used with a set of mono or stereo headphones, providing the same signal to each ear. Now, raise the **VOLUME** knob (clockwise) to bring the sound to an appropriate level.

WARNING: Do not use a TRS (balanced) cable for line output applications, as this will cause phase cancellation and can produce a very weak signal.

KENSINGTON SECURITY SLOT

Your Labyrinth can be securely attached to a desk, stand, or other fixture by connecting a Kensington security device to this slot.

ABOUT LABYRINTH

Labyrinth is a parallel generative analog synthesizer based around two complimentary voice paths and a powerful generative dual sequencer.

Labyrinth's voice architecture features a unique parallel processing path that includes both circuits for subtractive synthesis and complex spectra generation. It features a newly designed Voltage-Controlled Wavefolder, a Voltage-Controlled Filter that can morph between low-pass and band-pass modes, voltage-controlled blending between the two parallel voice paths, and a wealth of modulation options both hard-wired and patchable. The dual sequencer is designed around a generative process that can play two separate poly-metric sequences of up to eight steps each, or a single sequence up to 16 steps which can be used to control the oscillators and processing elements of Labyrinth. Taken together, Labyrinth can easily and quickly generate a wide range of mutating timbres like deep kick drums, electric bongos, alien bell tones, twisted FM sounds, or delicate sine wave melodies.

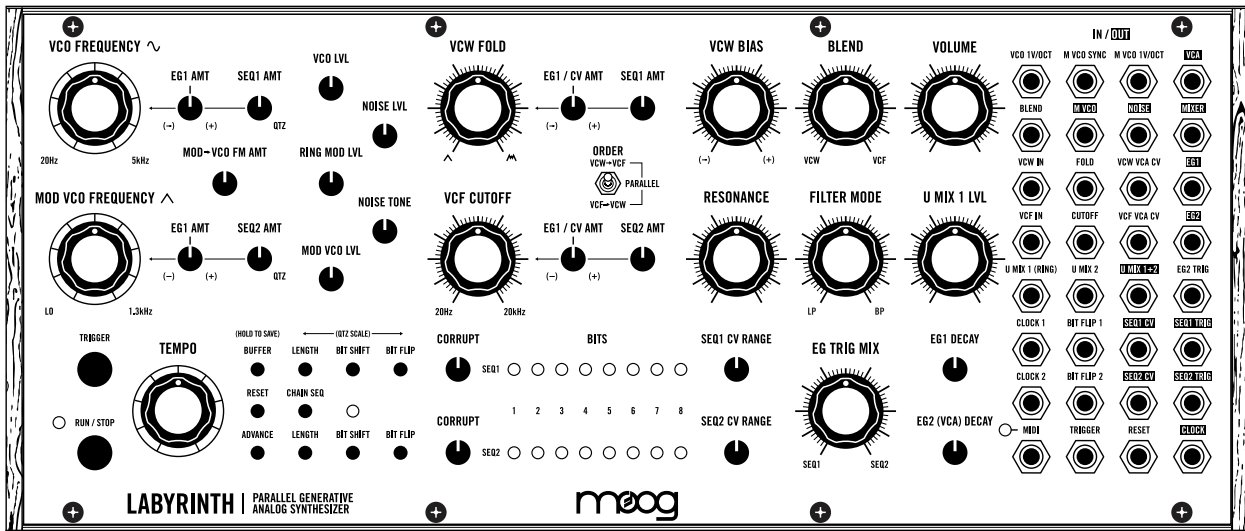

Labyrinth is a mosaic of various synthesis circuits and generative sequencing elements capable of being reconfigured through its highly flexible patch bay. It is an instrument designed for deep, immersive exploration—one whose patterns bloom over time, but whose evolution can be locked into place when something striking is encountered.

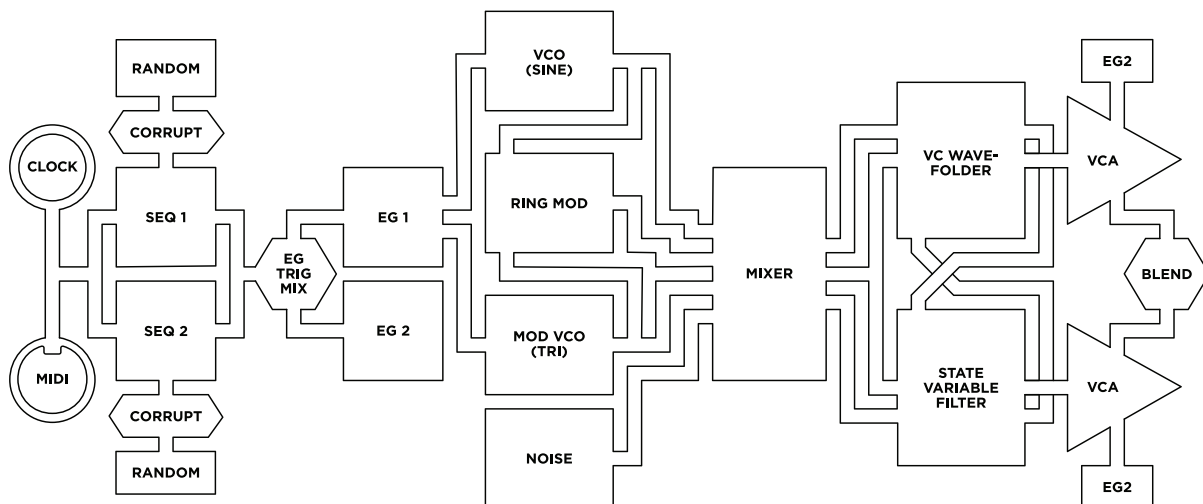

DUAL OSCILLATORS PAGES 25 & 26

Two oscillators (one sine wave Voltage-Controlled Oscillator [VCO] and one wide-range triangle **MOD VCO**) plus their **RING** modulated output and variable-tone **NOISE** generator all fed into a saturating mixer

WAVEFOLDER PAGE 28

Unique diode-transistor hybrid Voltage-Controlled Wavefolder (**VCW**) with smooth **VCW FOLD** control and manual **VCW BIAS** control for adding complex harmonics

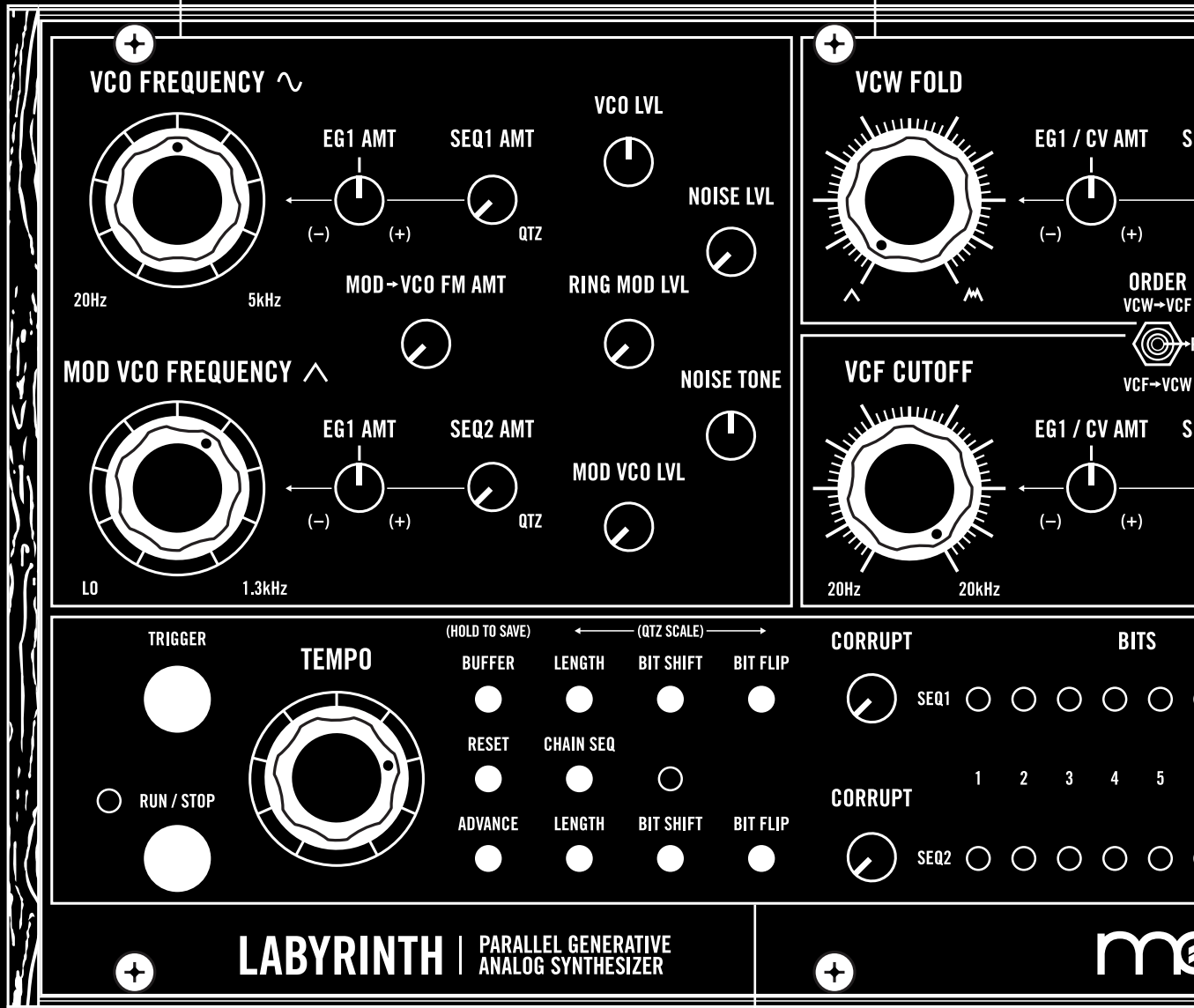

LABYRINTH

DUAL SEQUENCER PAGE 12

Generates random patterns and melodies with two 8-step sequencers that have minds of their own—able to work in parallel or series, quantized or unquantized, stable or constantly mutating

ENVELOPE/VCA CONTROLS PAGE 34

Voltage-Controlled **BLEND** between the **VCW** and **VCF** in parallel or series configurations, a Voltage-Controlled Amplifier (**VCA**) for each audio path, and two Envelope Generators (**EGs**) with variable **DECAY**

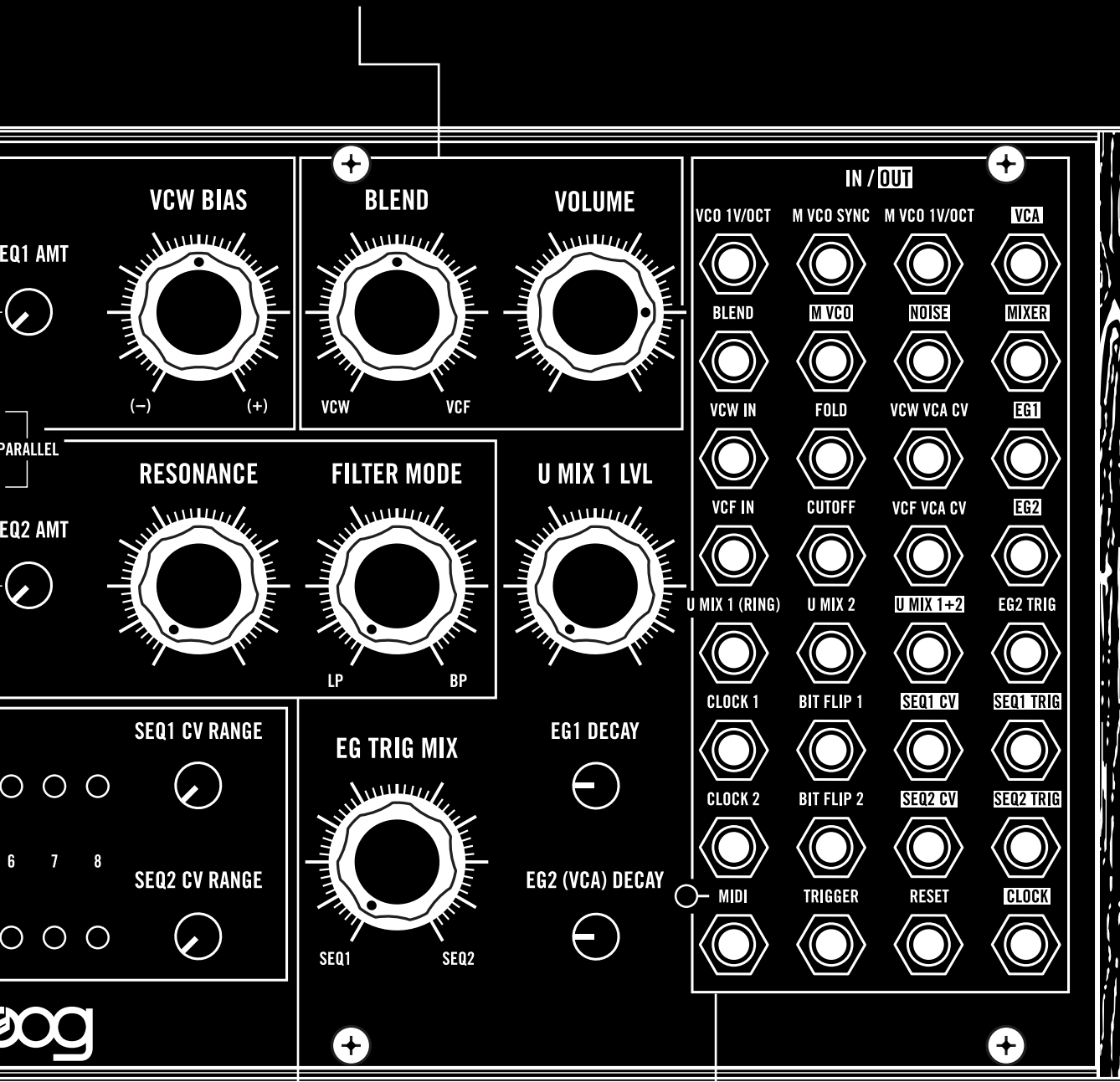

FILTER PAGE 30

2-pole state-variable Voltage-Controlled Filter (**VCF**) allowing for blending between filter responses, voltage control of **VCF CUTOFF** frequency, and manual **RESONANCE** control

PATCH BAY PAGE 39

32-point modular patch bay with 12 outputs and 20 inputs

PARALLEL VOICES

Labyrinth's voice begins with two analog Voltage-Controlled Oscillators (**VCOs**): a sine wave **VCO**, and a lower-frequency triangle-wave **MOD VCO**. These low-harmonic oscillators can frequency-modulate each other for complex analog FM tones and are ring-modulated for further broadband tone generation. The two VCOs, their **RING** modulation, and a variable-tone **NOISE** generator are mixed in a saturating mixer, adding harmonics and warm saturation to the four signal sources.

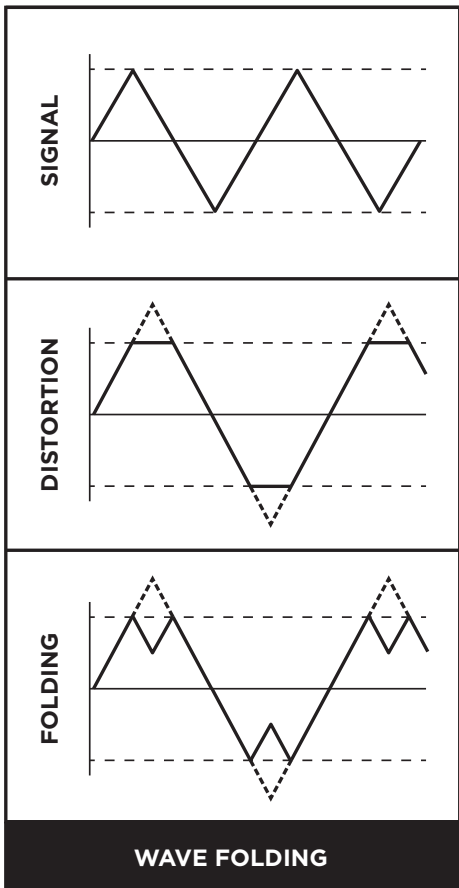

From here, the **MIXER** output takes two separate paths: the Voltage-Controlled Wavefolder (**VCW**) path and the subtractive Voltage-Controlled Filter (**VCF**) path. The **VCW** path amplifies a signal to the point of distortion, but instead of clipping the signal folds it over on itself, creating a wide range of upper harmonics. The manual **VCW BIAS** control shifts the DC offset in the wavefolder, changing the symmetry of the wavefolding and emphasizing even or odd harmonics.

The **VCF** path features a 2-pole state-variable filter which has voltage control over the **VCF CUTOFF** frequency and manual control over its **RESONANCE**. There is also manual control over the **FILTER TYPE**, morphing from a lowpass (**LP**) filter to a bandpass (**BP**) filter for either precise tonal shaping or resonant subtractive filter sweeps.

BLEND and **ORDER** control how these two parallel voice paths are brought back together. With **ORDER** set to **PARALLEL**, each path (**VCW** and **VCF**) is processed independently and combined via the **BLEND** control, which is a voltage-controlled crossfader. You can jump between these parallel paths using CV from the sequencer, use one of the two Envelope Generators to slide between additive and subtractive paths over time, or modulate **BLEND** with the **MOD VCO** for dense tones.

The **ORDER** switch will rearrange and intermingle these paths: set to **VCW → VCF**, the output of the **VCW** will be fed into the **VCF**, so that you will blend between the **VCW** signal on one side and the **VCW** signal fed through the **VCF** on the other. Setting **ORDER** to **VCF → VCW** inverts this, sending the output of the **VCF** through the **VCW** path so that you blend between the **VCF** signal fed through the **VCW** on one side and the **VCF** signal on the other. Each path, **VCW** and **VCF**, has its own Voltage-Controlled Amplifier (**VCA**) which is controlled by Envelope Generator 2 (**EG2**)—a decay-only envelope with manual control over the decay time.

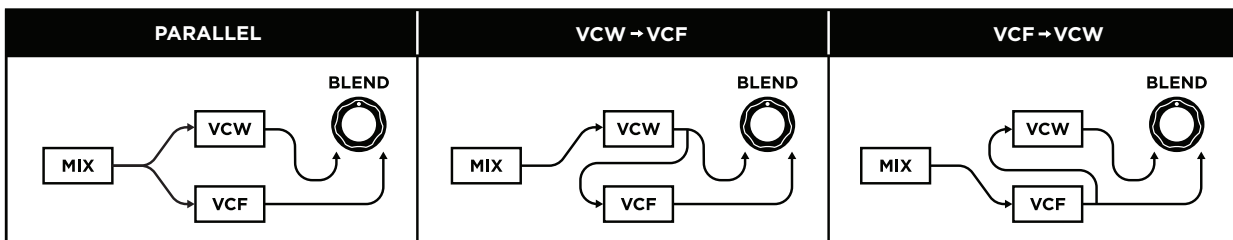

ORDER SWITCH

DUAL GENERATIVE SEQUENCERS

The core of Labyrinth is its dual generative sequencer. Each sequencer (**SEQ1, SEQ2**) consists of eight bits—each of which can be either on (LED red) or off (LED off). They are clocked by the internal clock set by **TEMPO** by default. Each sequencer additionally has its own 3.5mm **CLOCK** input for external clocking, and each will respond to MIDI clock as well.

As the play head (represented by a green LED) of the sequencer runs through the sequence, a trigger is output whenever the current bit is on (LED red). When the play head reaches the end of the sequencer it loops back to the beginning, making each **SEQ** a basic eight-step sequencer. The **LENGTH** of either sequencer can be set to any length from 1 to 8 by pressing its respective **LENGTH** button until the desired length is achieved, and each sequencer's sequence can be rotated by one bit to the right via the **BIT SHIFT** button. Additionally, both SEQs may be chained together using **CHAIN SEQ** to form a single sequence of up to 16 steps.

Travelling in sync with the play head is the write head (indicated by a red LED flashing in time with the incoming clock). Pressing **BIT FLIP** on the current bit location of the write head will flip that bit either on or off. When a bit is flipped on, a random voltage value between -5V and +5V is generated and stored in that bit location. By flipping bits on, a random sequence of voltages is generated in each SEQ which can be used to control the **VCO, MOD VCO, VCW FOLD, and VCF CUTOFF** to create generative patterns.

***NOTE:** The play head and write head by default are at the same position. For advanced sequencer operation, you may offset the write head from the play head via the **BIT SHIFT + ADVANCE** button combination—see the “Sequencer Button Combos” table on page 37.*

The voltage values of each sequencer are attenuated by the **SEQ1/SEQ2 CV RANGE** potentiometers and then sent to the internal quantizer (reference the “Sequencer Button Combos” and “Sequencer Quantization Modes” tables in this manual to set the internal quantizer). By playing with the **SEQ1/SEQ2 CV RANGE** knob you can adjust the range of the patterns generated by each SEQ and they will always be in the scale set by the quantizer!

With **CORRUPT** set fully counterclockwise each SEQ will continue looping its current sequence. As you increase the **CORRUPT** function you will increase the probability that a voltage value stored at a bit location will change to a new random voltage value as the write head passes over it. With **CORRUPT** below 12 o'clock only the voltage values will be affected, preserving the rhythmic pattern in the SEQ even as the voltage values change. As you increase **CORRUPT** above 12 o'clock you will additionally begin to increase the probability that the bits themselves will randomly flip.

EXPLORING LABYRINTH



In this section we will walk through Labyrinth’s main components in order to familiarize ourselves with its layout. There are infinitely many paths through Labyrinth, but by starting from the basics and working our way up we can more confidently navigate its terrain.

Labyrinth is a powerful generative synthesizer driven by random processes. The chance operations at its core mean that fully reproducing a sound or pattern from one Labyrinth to the next is not just difficult, but impossible. Therefore, parts of this section will only be able to gesture toward a family of sounds and patterns—not definite, precise ones. We encourage you to view this through a liberatory lens and to experience the sounds of Labyrinth as they emerge.

■ STEERING THE SEQUENCER

To begin, match your Labyrinth’s panel settings to the figure above—an initialized home base that we will use to get familiar with the sequencer. With the above panel configuration, we reduce Labyrinth to the simplest voice possible: a sine wave VCO with no filtering or wavefolding. Connect the rear **AUDIO OUT/IN** of Labyrinth to some kind of monitoring system if you haven’t already (a mixer, an interface, or some headphones). You won’t hear anything just yet.

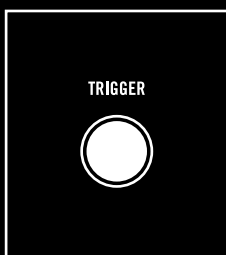

Press the **TRIGGER** button and you will hear a sine wave tone that quickly decays. If you don’t hear anything when you press **TRIGGER**, double-check your monitoring system or front panel settings.

EXPLORING LABYRINTH *(Continued)*

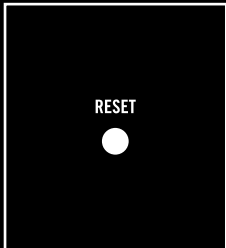
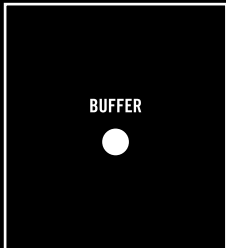

BUILDING A RHYTHM

Labyrinth comes with its sequencers pre-populated with sequences, so if you feel like diving in and seeing what happens before getting deep into the world of patching, feel free to press **RUN/STOP** and explore on your own! But in this guide, we will clear out the sequencers and begin from scratch. To do this, hold the **BUFFER** and **RESET** buttons down at the same time for one second to clear all data from the sequencers.

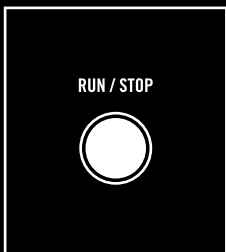

SEQ1 has eight **BIT** locations (i.e., eight “steps” that it runs through). Press **RUN/STOP** and you will see the green LED representing the play head begin to move through the sequencer and loop back to the beginning when it reaches the end. You won’t hear anything at this point since the sequencers are empty, so press **RUN/STOP** to stop the sequencer.

NOTE: SEQ2 is identical to SEQ1, but for now we will just focus on SEQ1.

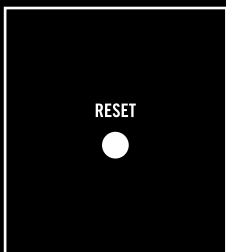

Press **RESET** to reset **SEQ1** back to step 1.

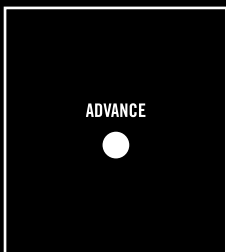
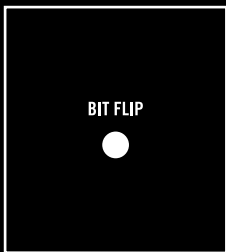

Now press the **SEQ1 BIT FLIP** button and you will see the green flashing LED on **SEQ 1** bit 1 turn orange, indicating that you have flipped bit 1 on. Press **ADVANCE** and you will move the play head forward to bit 2. Notice that the LED for bit 1 is now red, indicating that it is on.

EXPLORING LABYRINTH *(Continued)*

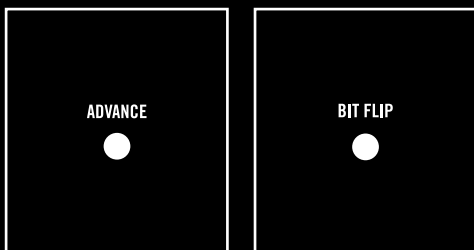

Press **ADVANCE** again to move the play head to bit 3 and then press **BIT FLIP** to turn bit 3 on. Press **ADVANCE** twice to move to bit 5 and flip it on, press **ADVANCE** again to move to bit 6 and flip it on, and then press **RESET** to jump back to bit 1. You now have a rhythmic sequence with notes on steps 1, 3, 5, and 6.

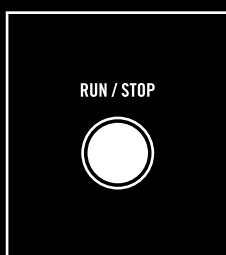
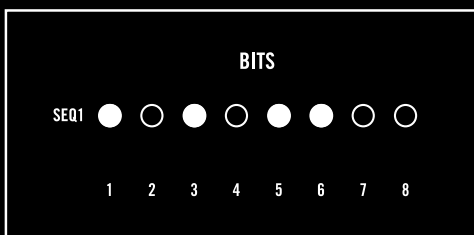

Now press **RUN/STOP** and watch as the play head moves through the sequence, triggering a note every time it hits a bit that is on.

FROM RHYTHM TO MELODY

Now that we have a basic rhythm down, let's unlock the CV sequencing power of Labyrinth.



First, increase the **SEQ1 AMT** knob next to the sine wave VCO all the way up so that it points to **QTZ**. At this time, you will not hear a change because **SEQ1 CV RANGE** next to **SEQ1** is fully counterclockwise.

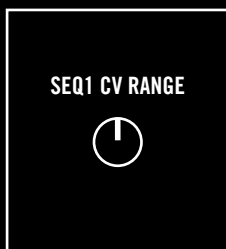

Now, increase **SEQ1 CV RANGE** to about 12 o'clock and you will hear the pitch of the VCO move in time with **SEQ1**. Each bit turned on in **SEQ1** contains a random voltage between -5 volts and +5 volts—a range of 10 octaves! The **SEQ1 CV RANGE** knob scales the voltages coming from **SEQ1**; turned all the way clockwise you will hear lower low notes and higher high notes (the full 10-octave range). Set around 9 o'clock, you will hear the same pattern, but with its range reduced to only an octave or so. Play with **SEQ1 CV RANGE** to get a better feel for how it affects the sequence range.

EXPLORING LABYRINTH *(Continued)*

NOTE: To tune Labyrinth to a specific key, turn the **SEQ1 CV RANGE** knob fully counterclockwise. You can now tune the **VCO FREQUENCY** to the root note of your scale. As you increase **SEQ1 CV RANGE**, the sequencer voltages will spread in a bipolar fashion with the root note you tuned in the center.

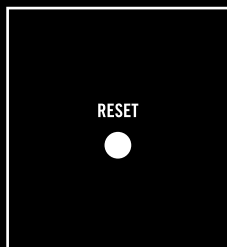
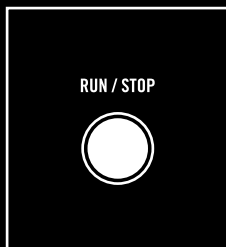

The sequencer of Labyrinth generates a completely random voltage between -5 volts and +5 volts every time a bit is flipped on. Press **RUN/STOP** to stop the sequencer, and press **RESET** to set the play head to bit 1. Press **BIT FLIP** to flip bit 1 off, and then press it again to flip bit 1 back on. Now, when you press **RUN/STOP** to play the sequence again, you will notice that the voltage value at bit 1 is different from what it was before, while the notes at bits 3, 5, and 6 are the same!

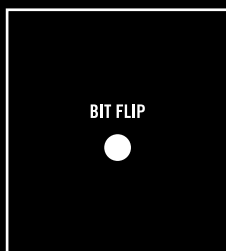

NOTE: If you don't perceive a difference, turn **SEQ1 CV RANGE** next to **SEQ1** and make sure **SEQ1 AMT** next to the **VCO** is fully clockwise.

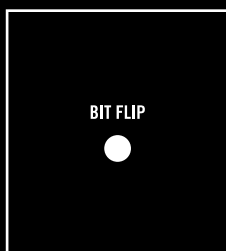

You can also flip bits as the sequencer is running by pressing **BIT FLIP**, which will flip the bit in the current bit location either on or off depending on its current state. Holding **BIT FLIP** down as the sequencer runs through the sequence will flip every on bit off and every off bit on—the latter producing a new random voltage at that particular bit.

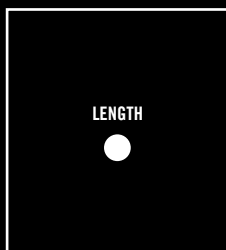

ADDITIONAL TRANSPORT CONTROLS

Pressing the **LENGTH** button for **SEQ1** will shorten the sequence to 7 bits. Pressing again will shorten to 6 bits, and on and on until you reach a sequence length of 1 bit, upon which pressing **LENGTH** again will reset to a sequence 8 bits long.

NOTE: You can reset the length of **SEQ1** to 8 steps by pressing **LENGTH + RESET** at the same time.

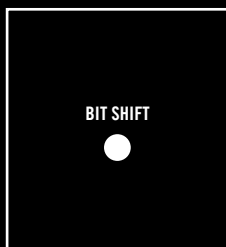

Pressing the **BIT SHIFT** button for **SEQ1** will shift the entire current sequence to the right by 1 bit, using whatever was stored at bit 8 wrapping back around to bit 1. If the sequence **LENGTH** is anything shorter than 8 bits, only the bits in the current **LENGTH** of the sequence will be affected by **BIT SHIFT**.

NOTE: You can rotate the bits of **SEQ1** back to their original positions by pressing **BIT SHIFT + RESET** at the same time.

EXPLORING LABYRINTH *(Continued)*

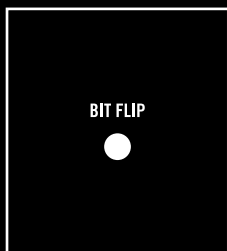
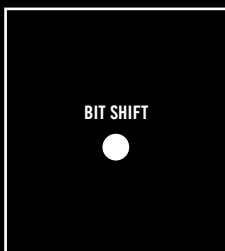

QUANTIZATION

While Labyrinth is a generative synthesizer based on random voltages, it can transform those random patterns into melodies via its quantizer. Labyrinth has a bank of 15 different scales, and by enabling a particular scale each random voltage is mapped to the closest note in that scale.

To change the quantizer scale, hold down the **BIT SHIFT** button of **SEQ1** and press **BIT FLIP**; do this while the sequencer is running so that you can hear the difference as you change quantization settings. You will see the 16 LEDs for **SEQ1** and **SEQ2** light green, and a red LED will indicate the current quantization setting (see “Sequencer Quantization Modes” on page 38). If you purchased your Labyrinth brand new, your quantizer will be set to the scale of bit number 3 in **SEQ1**, which indicates a major scale setting.

NOTE: By holding **BIT SHIFT** and pressing **BIT FLIP** you increment to the next quantizer mode, and by holding **BIT SHIFT** and pressing **LENGTH** you decrement to the previous quantizer mode.



RANDOM MUTATIONS WITH CORRUPT

CORRUPT introduces yet another dimension of randomness to Labyrinth by mutating your sequence. Increase the **CORRUPT** knob of **SEQ1** to about 11 o'clock while the sequencer is running, and you will begin to perceive your notes starting to change. This is because as **CORRUPT** is increased from fully counterclockwise to 12 o'clock the random voltages stored at the bits that are on will update to new random voltages as the write head passes over them. With **CORRUPT** set low the probability of a note change as the write head passes by is very low, while the probability is around 25% when **CORRUPT** is set near 12 o'clock.

From 12 o'clock to fully clockwise the probability of a note change at your bits that are on increases from 25% to about 50%. At the same time, above 12 o'clock **CORRUPT** begins to randomly flip your bits as well, from a 0% chance of bit flip below 12 o'clock to near 50% when **CORRUPT** is fully clockwise. Therefore, at max **CORRUPT**, the current note and bit state is just as likely to change as it is to stay the same.



CORRUPT therefore allows you to take your current pattern and let it start to drift away, mutating into new patterns and melodies. Try turning **CORRUPT** fully clockwise, letting Labyrinth create completely random melodic patterns, and then turn **CORRUPT** fully counterclockwise to lock the current pattern in.

EXPLORING LABYRINTH *(Continued)*

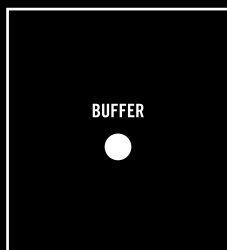

If you really like the current pattern, hold the **BUFFER** button until all LEDs flash green. This will save your current pattern into memory. Now you can increase **CORRUPT** to taste, letting your pattern drift off into new territories, and short-press **BUFFER** to instantly reload the sequence that you saved into memory.

NOTE: *There is only one memory location, so you cannot save multiple patterns. **BUFFER** saves the state of both **SEQ1** and **SEQ2**.*

SECOND SEQUENCER, CHAINING, AND MORE

Now that we have a handle on how **SEQ1** works, it's a good time to remember that Labyrinth has a second sequencer!

SEQ2 functions identically to **SEQ1**, so a thorough rundown is not necessary. Let's add **MOD OSC** as a second melodic line sequenced by **SEQ2** to have two sequences playing together.



Start by turning the **SEQ1 AMT** knob next to the VCO all the way down to hear its base frequency setting.

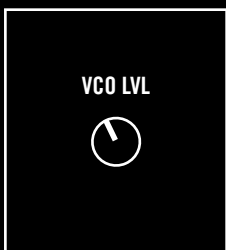

Next, turn up the **MOD VCO LVL** in the mixer to around 11 o'clock to add the **MOD VCO** to the mix and make sure the **VCO LVL** is also around 11 o'clock to get pure tones from the two oscillators. Press **TRIGGER** to hear both oscillators at the same time and adjust **MOD VCO FREQUENCY** until the two oscillators are in tune.

NOTE: *The **MOD VCO** has a much lower and wider frequency range, so for **VCO** and **MOD VCO** to be in tune their knobs will not be in the same place!*

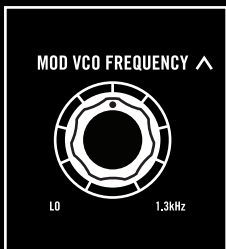
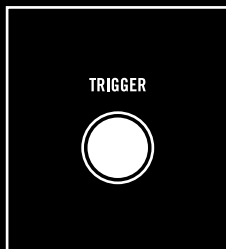

EXPLORING LABYRINTH *(Continued)*



Build a sequence in **SEQ2** just like you did in **SEQ1** and route it to the **MOD VCO** by moving the **SEQ2 AMT** knob next to the **MOD VCO FREQUENCY** fully clockwise. Move the **VCO SEQ1 AMT** knob next to **VCO FREQUENCY** fully clockwise again, and experiment with listening to both sequencers sequencing the two oscillators at the same time.



EG TRIG MIX is a rhythmic balance control, determining which stream of triggers is sent to the envelope generators. Fully counterclockwise only **SEQ1**'s triggers will trigger the envelope generators, and fully clockwise only **SEQ2**'s will. In between you will get a nice rhythmic balance, with the triggers from one sequencer at a higher velocity than the other (unless set to 12 o'clock, where each trigger stream will be at the same velocity). **EG TRIG MIX** therefore allows you to create dynamic patterns with different accents.

NOTE: The **EG TRIG MIX** control really shines when **SEQ1** and **SEQ2** have different rhythms at different lengths. Play with **EG TRIG MIX** while the sequencers are running to hear all of the different dynamic permutations of the two **SEQs** against each other.

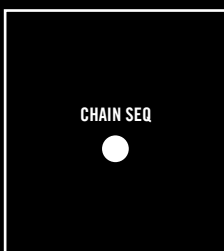

Finally, pressing **CHAIN SEQ** links **SEQ1** and **SEQ2** together for a single sequence of up to 16 steps. The **SEQ1** and **SEQ2** play heads will be set in phase, traversing these 16 steps jointly for immediate parallel dual oscillator sequencing. These play heads can be offset from each other for round robin effects (see the “Sequencer Button Combos” on page 37) and can also be clocked differently via their independent **CLOCK** inputs. Combined with their individual **CV RANGE** attenuators, you actually have two 16-step sequencers that share steps but can be clocked, scaled, and offset completely independently!

■ NAVIGATING PARALLEL PATHS

With a basic understanding of Labyrinth's sequencers under our belts it is finally time to turn our attention to its sound engine. Labyrinth is, of course, far more than a sine wave synthesizer!

Return your panel settings to the same initialized panel state we started with back in the beginning of the “Exploring Labyrinth” section. Keep whatever sequence you have playing around—it will be easier to explore the sound network of Labyrinth with a repeating sequence playing.

EXPLORING LABYRINTH *(Continued)*

PLAYING WITH OSCILLATORS

Labyrinth contains two oscillators: the audio-range sine wave **VCO** and the low-range triangle-wave **MOD VCO**. As we explored in the previous section, both can be sequenced via their **SEQ1/SEQ2 AMT** knobs, which provide quantized sequences when turned all the way up at **QTZ**.

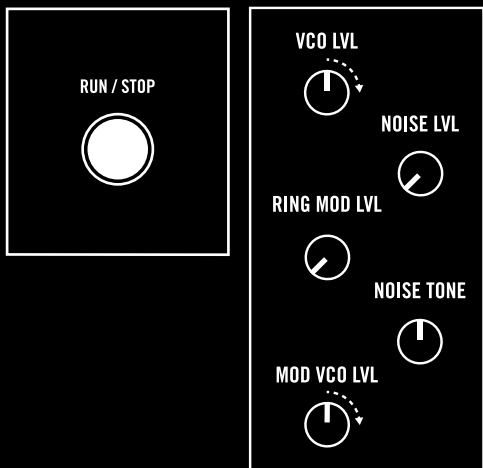

Press **RUN/STOP** to play the sequencer and bring up **MOD VCO LVL** in the mixer to around 12 o'clock. Each of the channels in the mixer of Labyrinth will overdrive above 12 o'clock. Play with the levels of the sine wave **VCO** and triangle-wave **MOD VCO** and observe how they saturate above 12 o'clock, adding crispy harmonics and overtones.



With the mixer you can also introduce the sound of the ring modulation of **VCO** and **MOD VCO** via the **RING MOD LVL** knob. Ring modulation is an effect that produces the sum and difference tones between two oscillators, and can be used to create metallic, inharmonic tones.

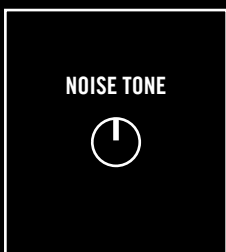
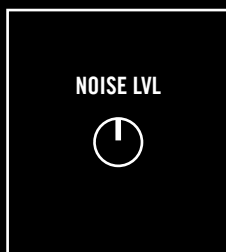

Also present in the mixer is a variable-tone **NOISE** generator. Add some **NOISE** via the **NOISE LVL** knob and adjust its spectral makeup via **NOISE TONE**, emphasizing low frequencies counterclockwise and higher frequencies clockwise.



Broader timbral depth can also be achieved with frequency modulation. Begin to raise the **MOD-VCO FM AMT** knob to hear the **MOD VCO** modulate the frequency of the **VCO**. The broad frequency range of the **MOD VCO** can provide anything from slow, subtle vibratos to wild and noisy audio-rate FM tones.

NOTE: The **MOD-VCO FM AMT** control uses thru-zero frequency modulation, which will keep the **VCO** in tune regardless of the **FM AMT** setting.

EXPLORING LABYRINTH *(Continued)*

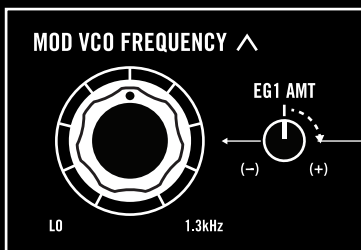

Finally, each oscillator contains a bipolar **EG1 AMT** control to add envelope modulation, which is especially useful in creating percussive sounds. Raise the **EG1 AMT** control next to the **MOD VCO** to add some bite, simulating a kick drum around 1 o'clock and laser zaps fully clockwise.

THE WAVEFOLDER PATH

From the mixer, Labyrinth splits into two paths: the Voltage-Controlled Wavefolder (**VCW**) path and the Voltage-Controlled Filter (**VCF**) path. Labyrinth contains the first Voltage-Controlled Wavefolder in a Moog instrument, so let's take a moment to explore the wavefolder in depth. Return your panel settings back to the initialized state back at the beginning of the "Explore Labyrinth" section so that we only hear the sine wave **VCO** (set to 12 o'clock in the mixer so that it remains clean and undistorted).

You can think of a wavefolder as something like the opposite of a filter. Whereas a filter subtracts harmonics, a wavefolder adds them. Many Moog synthesizers begin with a waveform containing many harmonics (such as a sawtooth or pulse wave) and use a filter to sculpt tones out of that rich base. Since a wavefolder adds tones, it is best to begin with the simplest waveform—a sine wave, which contains no harmonics—and build from there.

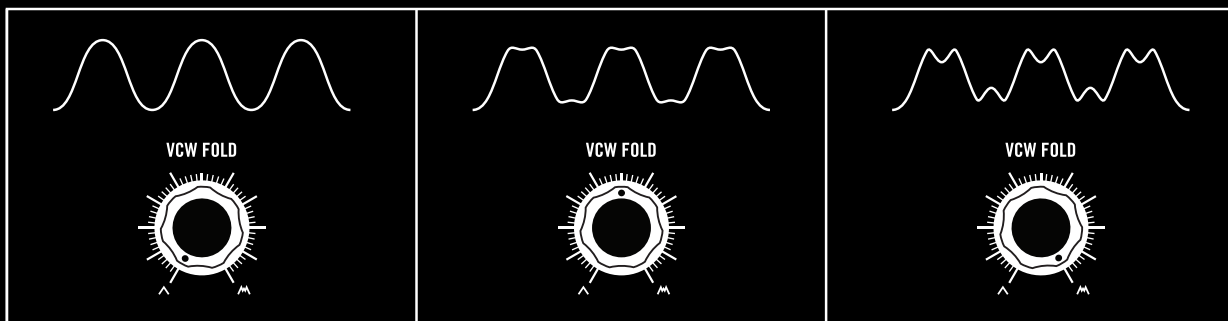

WAVE FOLDING

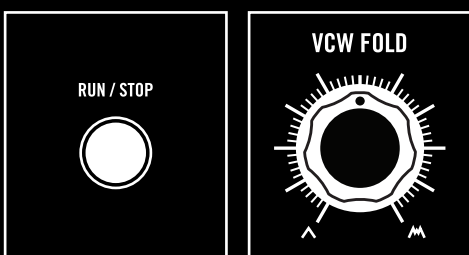

Press **RUN/STOP** to start the sequencer again and listen to the clean sine wave **VCO**. Begin to slowly increase the **VCW FOLD** knob and listen as the wavefolder adds harmonics. As you increase **VCW FOLD**, the sine wave approaches the point of distortion, but instead of clipping the tops and bottoms of the waveform off, the wavefolder *folds the wave back on itself*, creating a range of new harmonics.

EXPLORING LABYRINTH *(Continued)*

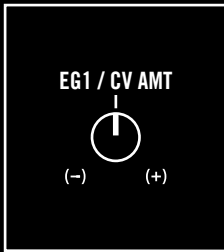

We also have two knobs for modulating the **VCW FOLD** parameter. **EG1/ CV AMT** is like the **EG1 AMT** knob found next to the oscillators, sending the envelope from **EG1** to modulate the **VCW FOLD** parameter in either a positive (clockwise) or negative (counterclockwise) direction. With an external control voltage patched to **VCW FOLD**, this attenuverter will instead scale the incoming CV.

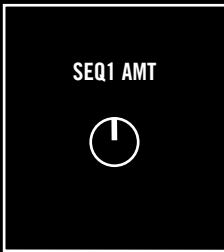

SEQ1 AMT sends the (bipolar) CV sequence from **SEQ1** to the **VCW FOLD** control. Start turning up **SEQ1 AMT** knob between **VCW FOLD** and **VCW BIAS** and listen to how each step in your sequence is wavefolded differently.

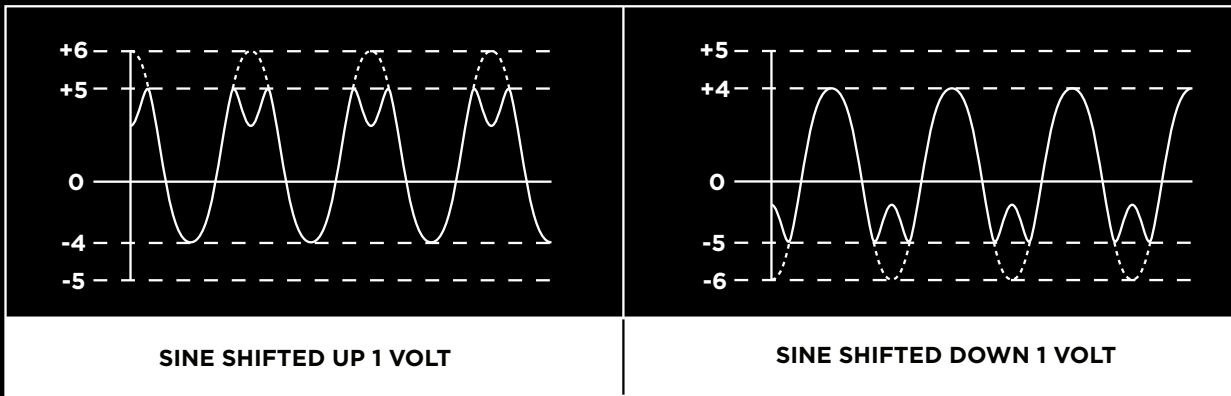

VCW BIAS

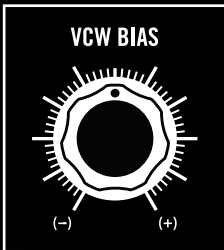

With **VCW FOLD** turned to around 12 o'clock we can also explore the **VCW BIAS** control. With **VCW BIAS** at zero (12 o'clock) the input to the wavefolder is centered around 0 volts, and thus as we increase folding with **VCW FOLD** the tops and bottoms of the wave hit the ceiling/floor in the same way and thus fold in the same way. **VCW BIAS** adds a DC bias voltage, centering the input wave around either a positive voltage (**VCW BIAS** clockwise) or negative voltage (**VCW BIAS** counterclockwise). These bias changes mean the input wave now hits the ceiling/floor asymmetrically, changing the flavor of harmonics created.

NOTE: You can mimic voltage control of **VCW BIAS** when the **MOD VCO** is at sub-audio rates by simply turning up **MOD VCO LVL** in the mixer. The slow **MOD VCO** will slowly shift the DC bias of the mix up and down!

EXPLORING LABYRINTH *(Continued)*

THE FILTER PATH

As a complement to the Voltage-Controlled Wavefolder (**VCW**), Labyrinth also contains a Voltage-Controlled Filter (**VCF**) which will subtract spectral components away. You are likely already much more familiar with the concept of a filter since filters have been a mainstay of Moog instruments since the 1960s, but the filter in Labyrinth creates a different tonal palette from previous Moog filters.

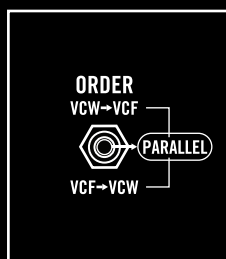
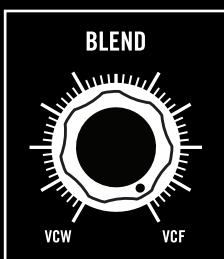

Turn the **BLEND** control fully clockwise and make sure that **ORDER** is set to **PARALLEL** (more on these controls below) to hear only the filter path and not the wavefolder. Playing with the **VCF CUTOFF** now will not show the full timbral possibilities of this control—sending a sine wave to a filter doesn't give the filter very much to grab on to.

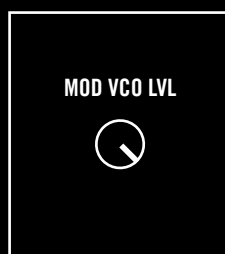
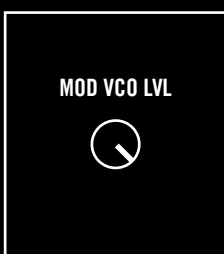

Turn up **VCO LVL**, **RING MOD LVL**, and **MOD VCO LVL** all the way in the mixer to mix all three signals and add lots of saturating overdrive. Turn up the **NOISE LVL** slightly as well to add some noise on top, and feel free to turn up **MOD→VCO FM AMT** as well. Now we have a signal full of harmonics for the filter to carve up.

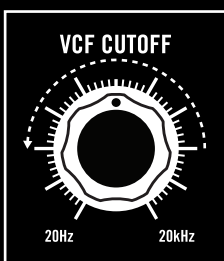

VCF CUTOFF will control the cutoff frequency of the filter, sweeping high frequencies away as it is turned counterclockwise. Just like with the **VCW FOLD** control, we have the **EG1/CV AMT** control to scale envelope modulation from **EG1** (or from an external CV patched into the **CUTOFF** input) to the **VCF CUTOFF**. **SEQ2 AMT** will route the control voltages from **SEQ2** to modulate the **VCF CUTOFF**, providing per-step tonal shaping possibilities.

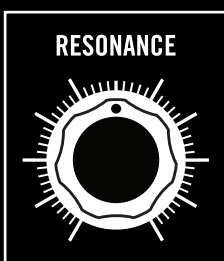

Turn up **RESONANCE** to add filter feedback, creating a peak in the frequency spectrum at the **VCF CUTOFF** frequency. Instead of using the classic Moog ladder filter, Labyrinth uses a 2-pole state-variable filter design which, in addition to changing the sonic characteristics of the filter, will not attenuate low frequencies when **RESONANCE** is turned up.

EXPLORING LABYRINTH *(Continued)*

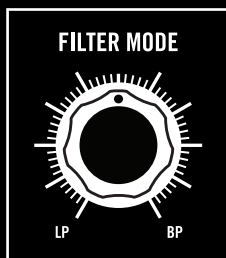
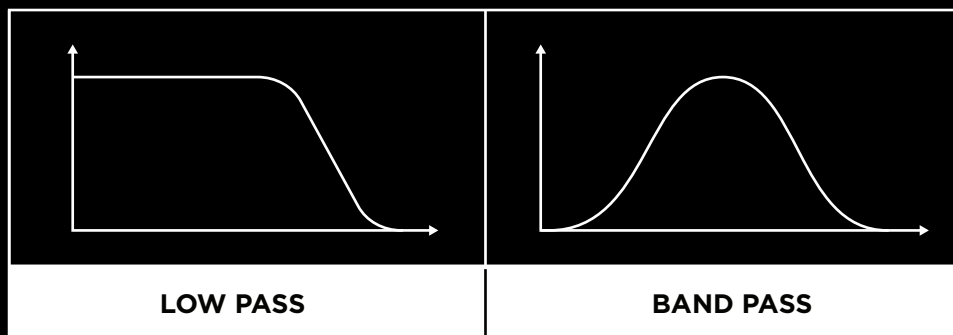

Finally, play with **FILTER MODE** to morph the filter response between lowpass (**LP**) and bandpass (**BP**). A lowpass filter will attenuate all frequencies above the **VCF CUTOFF** frequency, while a bandpass filter will attenuate frequencies both above and below the **VCF CUTOFF** frequency.

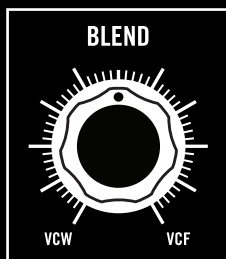

BRINGING THE PATHS TOGETHER

Both signal paths—the additive VCW path and the subtractive VCF path—are mixed together via the **BLEND** crossfader control. As your sequence plays, adjust the **BLEND** control as you simultaneously play with the **VCW FOLD** and **VCF CUTOFF** controls to explore the timbral space between these parallel paths.

EXPLORING LABYRINTH *(Continued)*

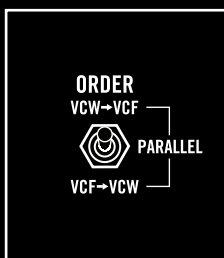
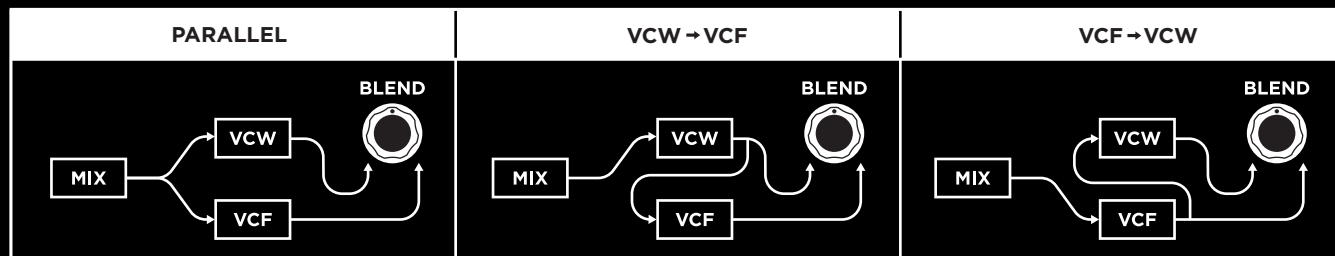

With the **ORDER** switch we can reroute these signal paths for further tonal exploration. Switch **ORDER** from **PARALLEL** to **VCW → VCF**.

This routes the output of the **VCW** to the input of the **VCF**, allowing you to filter the wavefolded harmonics with the **VCF**. Now, the **BLEND** control blends between the wavefolded signal on the left and the filtered wavefolded signal on the right.

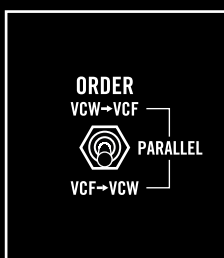

We can invert this with **ORDER** switched to **VCF → VCW**, allowing us to first filter the signal from the **MIXER**, and then wavefold that filtered signal. This can produce especially interesting sounds when using a bandpass filter response to fold only specific frequency ranges, or when combined with high **VCF RESONANCE** to create extra resonant grit. These extended routing options open up a wide space of timbral possibilities, especially with CV control over the **BLEND** parameter in the patch bay.

NOTE: Each path—**VCW** and **VCF**—has its own Voltage-Controlled Amplifier (**VCA**). **EG2** controls both **VCAs**, and the output of these two **VCAs** are sent to the **BLEND** control. This way, you can use both paths completely independently, or route **EG1** to one of the **VCAs** to have the dynamics of your sound decay at different rates in either signal path.

■ SUMMARY

In this walkthrough we have systematically explored two features at the heart of Labyrinth: its dual generative sequencer and its dual parallel voice path. Equipped with some familiarity of Labyrinth, we can now venture out and dive deeper with a clear idea of how to get back to home base if we need to.

From here, we can begin to explore some of the unique features of Labyrinth with the patch bay. Try using the utility mixer (**U MIX**) to create a submix, sending a separate audio mix to the **VCW** path, or even separating the two oscillators into two separate signal paths for a duophonic instrument. Use the **MOD VCO** to turn sequencer bits on and off with the **BIT FLIP CV** inputs, or cross the sequencers together and have both modulate a single oscillator.

PANEL CONTROLS AND FUNCTIONS

■ THE OSCILLATORS

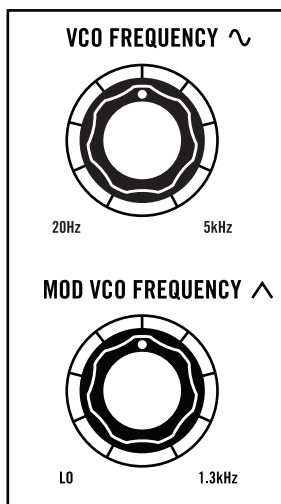

The building blocks of sound in Labyrinth are its two Voltage-Controlled Oscillators (VCOs). The sine wave **VCO** covers the audible frequency range, while the triangle-wave **MOD VCO** has a lower frequency range—perfect for modulation duties as an LFO, a low-frequency basis for a kick drum, or a melodic counterpoint to the **VCO**. Both oscillators can be modulated by **EG1** and by a sequence (**SEQ1** for the **VCO**, **SEQ2** for the **MOD VCO** by default). Metallic and inharmonic tones can be generated by their **RING MOD** output, and complex analog FM tones are created through the **MOD→VCO FM AMT** control.

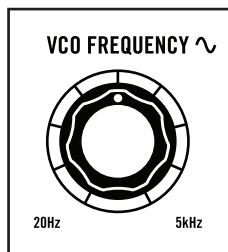

VCO FREQUENCY

This sets the frequency of Labyrinth's sine wave **VCO**—from ~20 Hz to ~5 kHz.

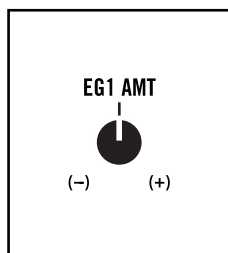

VCO EG1 AMT

This sets the amount that envelope **EG1** modulates the **VCO FREQUENCY**. It has bipolar control, with positive modulation above 12 o'clock and negative modulation below.

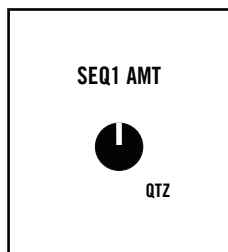

VCO SEQ1 AMT

This sets the amount that the sequence from **SEQ1** modulates the **VCO FREQUENCY**. Set all the way up (at **QTZ**) it will follow the quantized sequence from **SEQ1**.

THE OSCILLATORS *(Continued)*

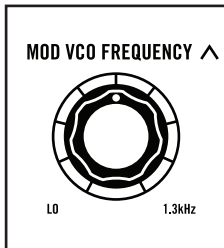

MOD VCO FREQUENCY

This sets the frequency of Labyrinth's triangle wave **MOD VCO**—from low frequencies to audio rate (~1.3 kHz).

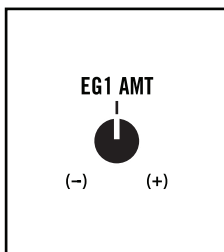

MOD VCO EG1 AMT

This sets the amount that **EG1** modulates the **MOD VCO FREQUENCY**. It has bipolar control, with positive modulation above 12 o'clock and negative modulation below.

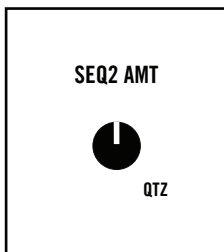

MOD VCO SEQ2 AMT

This sets the amount that the sequence from **SEQ2** modulates the **MOD VCO FREQUENCY**. Set all the way up (at **QTZ**) it will follow the quantized sequence from **SEQ2**.

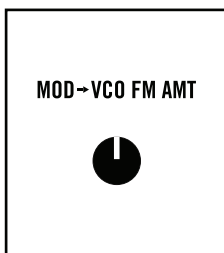

MOD->VCO FM AMT

This sets the frequency modulation depth from **MOD VCO** to **VCO**. This control utilizes thru-zero frequency modulation which will preserve the tonal center of the **VCO** regardless of the **MOD->VCO FM AMT** setting.

■ THE MIXER

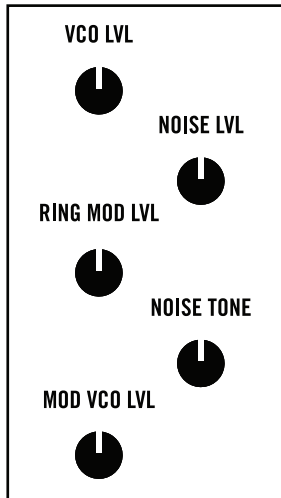

The two oscillators, as well as their **RING MOD** result, are summed in the **MIXER**. Each channel of the Labyrinth **MIXER** will begin to saturate and overdrive when increased above 12 o'clock. The **MIXER** also features a variable-tone **NOISE** generator.

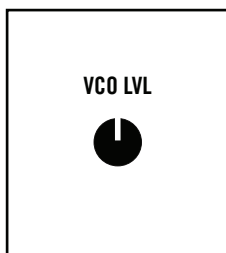

VCO LVL

This sets the level of the **VCO**. It overdrives above 12 o'clock.



RING MOD LVL

This sets the level of the **RING MOD** (VCO and MOD VCO are combined in the ring modulator). It overdrives above 12 o'clock.

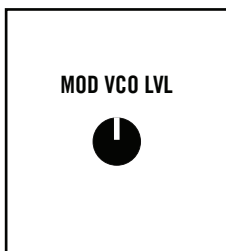

MOD VCO LVL

This sets the level of the **MOD VCO**. It overdrives above 12 o'clock.

THE MIXER *(Continued)*

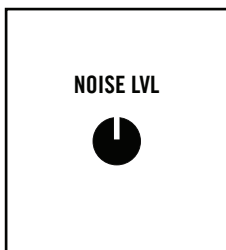

NOISE LVL

This sets the level of the **NOISE** generator. It overdrives above 12 o'clock.

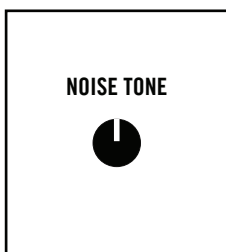

NOISE TONE

This provides tone control for the **NOISE** generator, emphasizing low frequencies to the left and higher frequencies to the right.

■ THE WAVEFOLDER

The output from the **MIXER** is sent to the Voltage-Controlled Wavefolder (**VCW**). This diode-transistor hybrid wavefolder is a complex timbral circuit that creates harmonics by increasing the gain of its input signal. While most diode-based wavefolders have several hard audible "breakpoints" where wavefolding begins, the Labyrinth wavefolder uses several novel techniques to smooth/eliminate those breakpoints and create more continuous wavefolding.

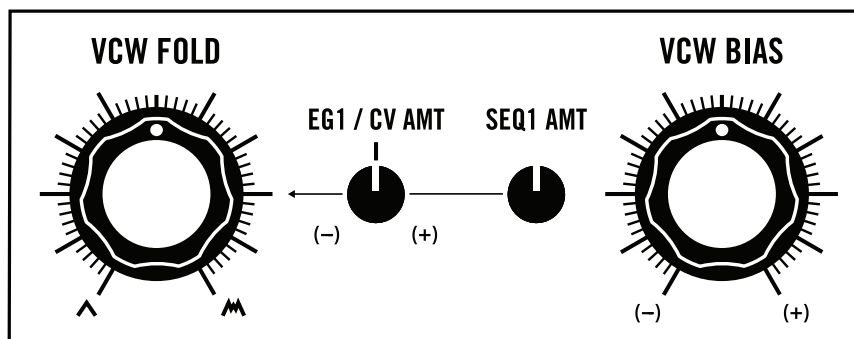

THE WAVEFOLDER *(Continued)*

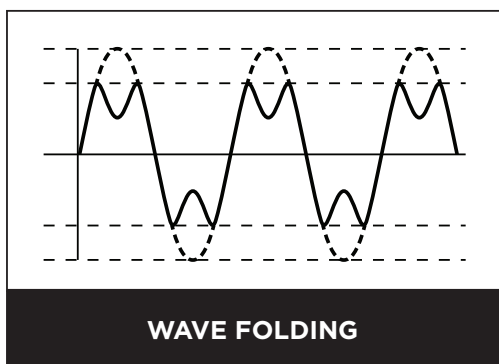

Normally, when the gain of an input signal exceeds the headroom of a circuit, the tops and bottoms of the waveform are clipped off, causing distortion (such as in the Labyrinth **MIXER**). A wavefolder, however, folds the sections of the signal exceeding the floor/ceiling back in on the signal itself, creating new harmonics in the process. The **VCW FOLD** control increases the depth of folding of the input signal, and the **VCW BIAS** control adds a DC bias (either positive or negative), achieving asymmetrical folding and emphasizing even or odd harmonics.

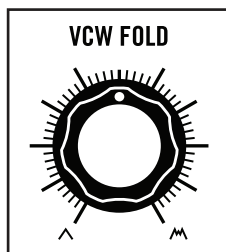

VCW FOLD

This sets the amount of wavefolding. It passes a clean signal all the way to the left with maximum wavefolding all the way to the right.

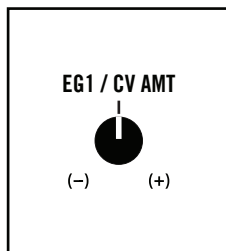

VCW EG1/CV AMT

This sets the amount that envelope **EG1** modulates **VCW FOLD**. It has bipolar control, with positive modulation above 12 o'clock and negative modulation below. **EG1/CV AMT** acts as an attenuverter for CV input to **VCW FOLD** if patched.

THE WAVEFOLDER *(Continued)*

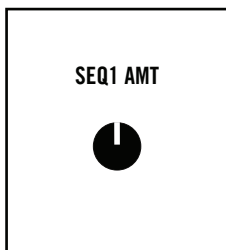

VCW SEQ1 AMT

This sets the amount that the sequence from **SEQ1** (post **SEQ1 CV RANGE** attenuator and quantizer) modulates **VCW FOLD**.

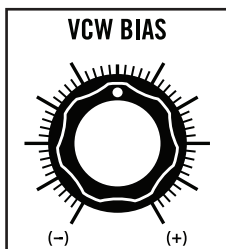

VCW BIAS

This sets the bias amount in the wavefolder, adding either a positive DC offset in the wavefolder above 12 o'clock or a negative DC offset below 12 o'clock.

■ THE FILTER

The output from the Labyrinth **MIXER** is sent both to the **VCW** and sent in parallel to the Voltage-Controlled Filter (**VCF**). Labyrinth features a 2-pole state-variable filter allowing for crossfading between lowpass (**LP**) and bandpass (**BP**) filter responses via the **FILTER MODE** control. **VCF CUTOFF** controls the cutoff frequency, **RESONANCE** adds a resonant peak at the cutoff frequency, and the **EG1/CV AMT** and **SEQ2 AMT** controls allow for dynamic timbral modulation.

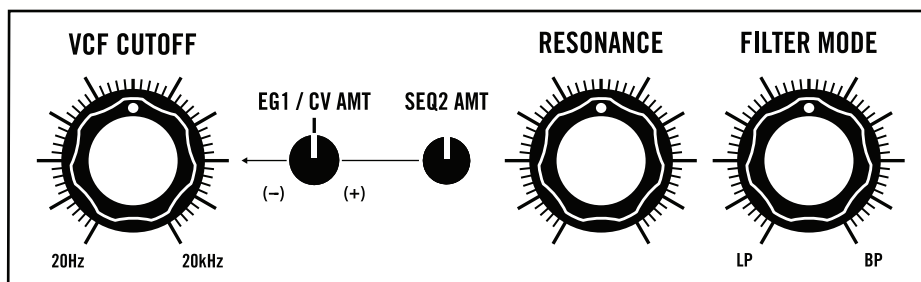

THE FILTER *(Continued)*

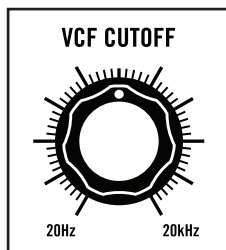

VCF CUTOFF

This sets the cutoff frequency of the filter—from 20 Hz to 20 kHz.

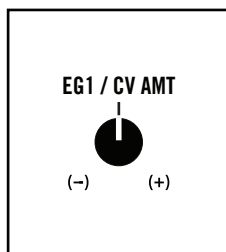

VCF EG1/CV AMT

This sets the amount that EG1 modulates **VCF CUTOFF**. It has bipolar control, with positive modulation above 12 o'clock and negative modulation below. **EG1/CV AMT** acts as an attenuverter for CV input to **VCF CUTOFF** if patched.

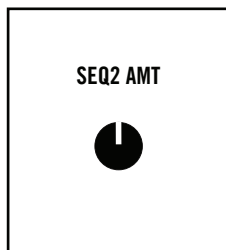

VCF SEQ2 AMT

This sets the amount that the sequence from **SEQ2** (post **SEQ2 CV RANGE** attenuator and quantizer) modulates **VCF CUTOFF**.

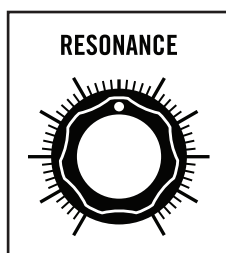

RESONANCE

This sets filter resonance—from no resonance to near self-oscillation.

***NOTE:** Unlike the traditional Moog ladder lowpass filter, you will notice that with **FILTER MODE** set to lowpass, turning up **RESONANCE** will not attenuate lower frequencies.*

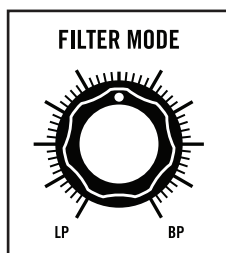

FILTER MODE

This sets the filter response—from lowpass (LP) all the way to the left to bandpass (BP) all the way to the right. **FILTER MODE** mixes the two filter types in between.

■ BLEND/AMPLIFIERS

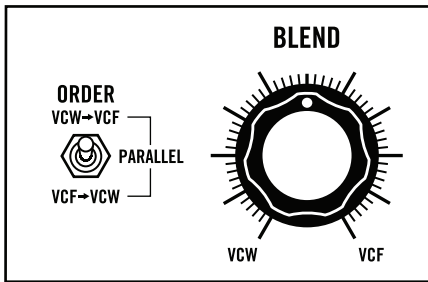

Both signal paths—the additive **VCW** path and the subtractive **VCF** path—are combined via the **BLEND** control, which crossfades between these two paths. Each signal path goes through its own Voltage-Controlled Amplifier (**VCA**), which are both controlled by EG2, before being sent to each side of the **BLEND** control. The **ORDER** switch allows you to reroute the signal paths in various ways for deeper timbral explorations.

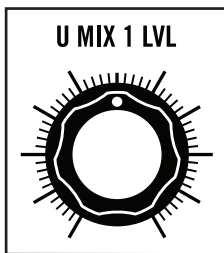

In this section you will also find the **U MIX** utility mixer, which features two inputs on the patch bay (**U MIX 1**, **U MIX 2**) and one output (**U MIX 1+2**). The level for **U MIX 1** (normalised to the **RING MOD**) is set by the **U MIX 1 LVL** knob, while **U MIX 2** is added to the mix at full strength.

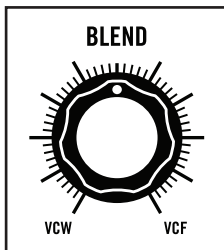

BLEND

This is the crossfader between the **VCW** output and **VCF** output.

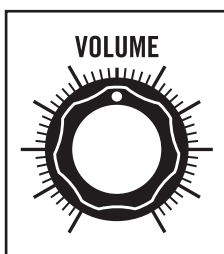

VOLUME

This sets the level of the signal at the 1/4" output and the **VCA** output on the patch bay.

BLEND/AMPLIFIERS *(Continued)*

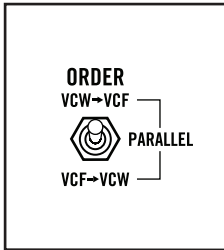

ORDER

This reroutes the internal signal routing to **VCW** and **VCF** paths:

PARALLEL	VCW → VCF	VCF → VCW
<p>Both VCW and VCF get their input from the MIXER.</p>	<p>VCW input is from MIXER; VCF input is from VCW output.</p>	<p>VCF input is from MIXER; VCW input is from VCF output.</p>

■ ENVELOPE GENERATORS

Labyrinth contains two envelope generators. EG1 can be routed to modulate **VCO FREQUENCY, MOD VCO FREQUENCY, VCW FOLD**, or **VCF CUTOFF** via the labeled bipolar attenuators next to their respective controls. **EG2** is normalised to control the VCAs of both the **VCW** signal path and the **VCF** signal path. Each envelope generator is a decay-only envelope triggered by the resulting sequencer trigger mix via **EG TRIG MIX**.

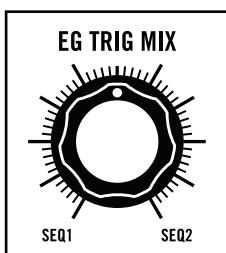

EG TRIG MIX

This blends between triggers from **SEQ1** and **SEQ2** which are sent to **EG1** and **EG2**. Fully counterclockwise, triggers from **SEQ1** have a velocity of 100% and triggers from **SEQ2** are suppressed. Fully clockwise, triggers from **SEQ1** are suppressed and triggers from **SEQ2** have a velocity of 100%. At 12 o'clock, triggers from both SEQs are at equal levels.

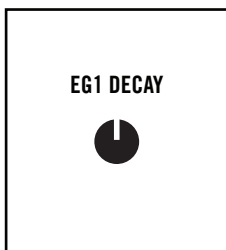

EG1 DECAY

This sets the decay time for **EG1**. The envelope generator produces a percussive envelope with no attack time and variable decay from around 10 milliseconds to greater than five seconds.

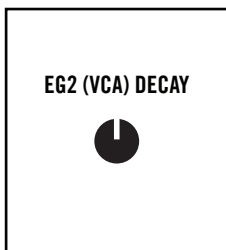

EG2 (VCA) DECAY

This sets the decay time for **EG2** which is internally patched to the **VCW** and **VCF** VCAs. The envelope generator produces a percussive envelope with no attack time and variable decay from around 10 milliseconds to greater than five seconds.

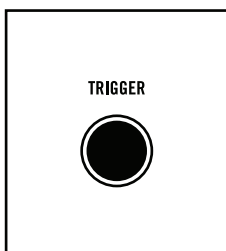

TRIGGER

This manually triggers both **EG1** and **EG2**.

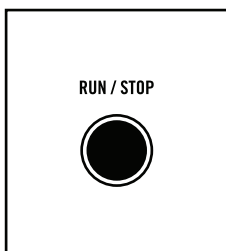

RUN/STOP

This starts/stops **SEQ1** and **SEQ2**. These sequencers do not reset when stopped/started; they can be overridden via MIDI Start/Stop/Continue commands.

■ SEQUENCER TRANSPORT CONTROLS

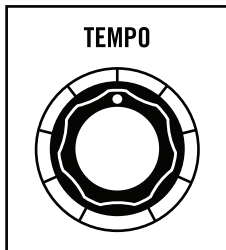

TEMPO

This sets the tempo of internal **CLOCK** used to clock both sequencers.

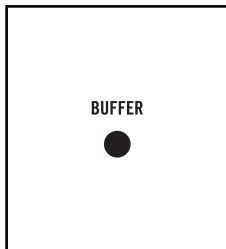

BUFFER

Hold this for one second, and all LEDs will flash green. **BUFFER** saves bit states, quantization mode, write head offsets, sequence lengths, and **CHAIN SEQ** mode status to memory.

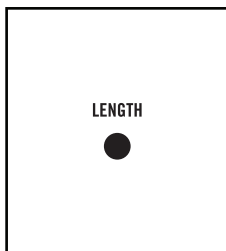

LENGTH (1,2)

Press to decrease length of **SEQ1** or **SEQ2** by one step. When you press **LENGTH** LEDs in **SEQ1** or **SEQ2** will light up green to indicate the current length of the SEQ. After length of 1 bit, **LENGTH** returns to 8.

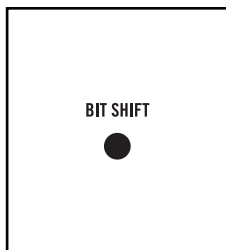

BIT SHIFT (1,2)

Press to shift all bits in **SEQ1** or **SEQ2** by one bit to the right. Bits at the end of the SEQ—depending on the length set by **LENGTH** (1,2)—will wrap around to bit 1.

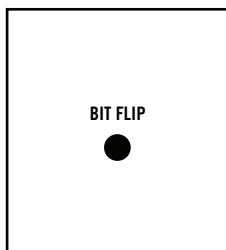

BIT FLIP (1,2)

When pressed, this will flip the current bit at the write head from its current state. If off, this will flip to on; if on, this will flip to off.

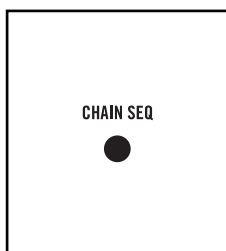

CHAIN SEQ

This chains **SEQ1** and **SEQ2** together for a max 16-step sequence. When chained, **BIT SHIFT 1** rotates all **SEQ1,2** bits together and **BIT SHIFT 2** rotates **SEQ2** play head.

SEQUENCER TRANSPORT CONTROLS *(Continued)*

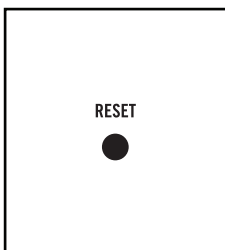

RESET

This resets play heads for **SEQ1** and **SEQ2** back to **BIT 1** and preserves write head offset.

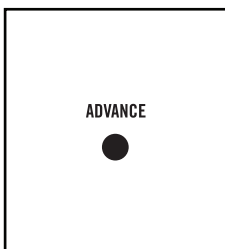

ADVANCE

This moves **PLAY** and write heads for **SEQ1** and **SEQ2** ahead one bit. **ADVANCE** is disabled when the sequencer is running.

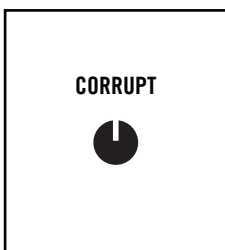

CORRUPT (1,2)

From fully counterclockwise to 12 o'clock, **CORRUPT** will increasingly randomly change the CV value located at the current write head position in **SEQ1** or **SEQ2**. Above 12 o'clock, it will flip the bit value as well with increasing probability. Fully counterclockwise, **CORRUPT** will not affect the values in the **SEQ**.

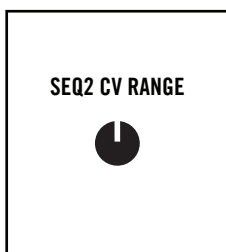
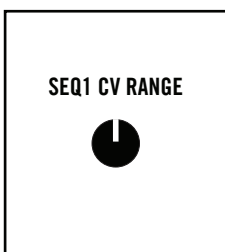

SEQ1,2 CV RANGE

Each time a bit in a SEQ is flipped on, a random CV value is generated between -5V and +5V. The **SEQ1,2 CV RANGE** potentiometer attenuates the CV values coming out of the sequencer before being sent to the internal quantizer.

■ SEQUENCER BUTTON COMBOS

Combo	Function	Description	LED Effect/ Feedback
LENGTH (1,2) + RESET	SEQ Length Reset	Resets length of SEQ1 or SEQ2 to 8.	Green LEDs flash to show new sequence length.
BIT SHIFT (1,2) + RESET	Rotate Reset	Rotates all bits of SEQ1 or SEQ2 back to original position.	None
BIT SHIFT (1,2) + ADVANCE	Shift WRITE head (1,2)	Shifts WRITE head forward 1 bit in relation to PLAY head.	None
BIT SHIFT (1,2) + ADVANCE + RESET	Reset WRITE head (1,2)	Returns WRITE head to PLAY head position.	None
BIT SHIFT (1) + LENGTH (1)	CV Quantize -	Decrements current quantization mode by 1.	All green LEDs light; red LED shows new quantization mode (1-16).
BIT SHIFT (1) + BIT FLIP (1)	CV Quantize +	Increments current quantization mode by 1.	All green LEDs light; red LED shows new quantization mode (1-16).
BIT SHIFT (2) (IN CHAINED MODE)	Chained Mode Offset	Moves SEQ2 PLAY head once, changing offset between SEQ1 and SEQ2 PLAY heads (in chained mode).	None
BIT SHIFT (2) + RESET (IN CHAINED MODE)	Chained Offset Reset	Snaps SEQ2 PLAY head to SEQ1 PLAY head, synchronizing both SEQs (in chained mode).	None
HOLD BUFFER 1 SEC	Buffer Save	Saves bit states, quantization mode, WRITE head offsets, and CHAIN SEQ mode status to memory.	All green LEDs flash three times if success.
HOLD BUFFER + RESET 1 SEC	Sequence Clear	Clears all bit states, quantization mode, and WRITE head offsets in current sequence.	None
BIT SHIFT (2) + LENGTH (2)	MIDI Clock Division -	Decrements current MIDI clock division by 1.	All yellow LEDs light; red LED shows new MIDI Clock division (1-16).
BIT SHIFT (2) + BIT FLIP (2)	MIDI Clock Division +	Increments current MIDI clock division by 1.	All yellow LEDs light; red LED shows new MIDI Clock division (1-16).
HOLD CHAIN SEQ ON STARTUP	MIDI Channel Select	Boots into MIDI Channel Select. Press BIT SHIFT (1) to increment, BIT SHIFT (2) to decrement, and CHAIN SEQ to confirm and return to normal operation. Default is OMNI.	All red LEDs light; green LED shows current MIDI channel. All green LEDs are OMNI. CHAIN SEQ LED flashes to indicate current mode. All green LEDs flash three times on confirm.
HOLD BUFFER + RESET ON STARTUP	Global Settings Select	Boots into Global Setting Select. See "Global Settings" section of this manual for more.	See "Global Settings" section of this manual for more. CHAIN SEQ LED flashes to indicate current mode. All green LEDs flash three times on confirm.

■ SEQUENCER QUANTIZATION MODES

Number (SEQ, BIT)	Scale
1, 1	Unquantized
1, 2	Chromatic
1, 3	Major
1, 4	Pentatonic
1, 5	Melodic Minor
1, 6	Harmonic Minor
1, 7	Diminished 6th
1, 8	Whole Tone
2, 1	Hirajoshi Pentatonic
2, 2	7 Sus 4 Scale (1 4 5 b7)
2, 3	Major 7th Scale (1 3 5 7)
2, 4	Major 13th Scale (1 3 5 6 7 9)
2, 5	Minor 7th Scale (1 b3 5 b7)
2, 6	Minor 11th Scale (1 b3 4 5 b7 9)
2, 7	Hang Drum Tuning
2, 8	Quads Tuning (Minor 3rds)

THE PATCH BAY

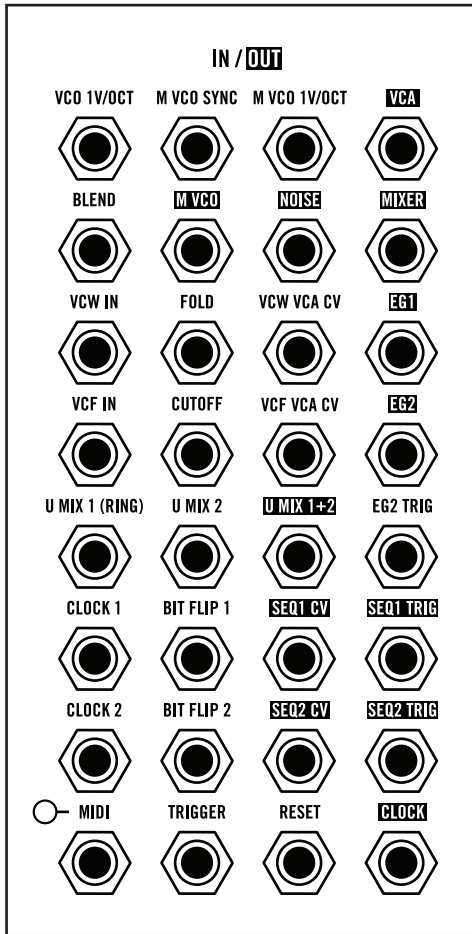

Labyrinth contains an extensive patch bay with 32 modular patch points: 20 inputs (white text on black) and 12 outputs (black text on white). As an extremely flexible semi-modular generative sequencer with two independent signal processing paths (VCW and VCF) and a utility mixer, Labyrinth is ready to make deep connections with all sorts of analog gear via control voltage (CV) and Eurorack-level audio over 3.5mm jacks.

In this section we will go over every patch point from right to left as we travel down the patch bay.

INPUTS:

VCO 1V/OCT
M VCO SYNC
M VCO 1V/OCT
BLEND
VCW IN
FOLD
VCW VCA CV
VCF IN
CUTOFF
VCF VCA CV
U MIX 1 (RING)
U MIX 2
U MIX 1+2
CLOCK 1
BIT FLIP 1
CLOCK 2
BIT FLIP 2
MIDI
TRIGGER
RESET

OUTPUTS:

VCA
M VCO
NOISE
MIXER
EG1
EG2
U MIX 1+2
SEQ1 CV
SEQ1 TRIG
SEQ2 CV
SEQ2 TRIG
CLOCK

ROW ONE

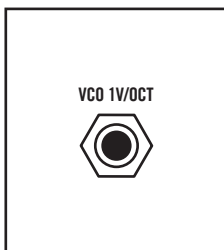

VCO 1V/OCT

This is a calibrated CV input that controls the frequency of the sine wave **VCO** following the 1 Volt per Octave standard. It is summed with the setting of the **VCO FREQUENCY** panel control.

CV INPUT: -5V to +5V

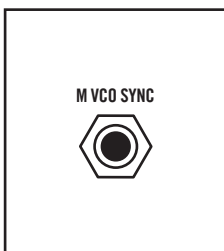

M VCO SYNC

This is the sync input for the **MOD VCO**. It resets the **MOD VCO** when the gate is high.

CV INPUT: 0V to +5V

PATCH BAY *(Continued)*



M VCO 1V/OCT

This is a calibrated CV input that controls the frequency of the triangle wave **MOD VCO** following the 1 Volt per Octave standard. It is summed with the setting of the **MOD VCO FREQUENCY** panel control.

CV INPUT: -5V to +5V

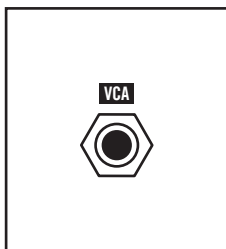

VCA

Labyrinth's audio output at Eurorack level (10 Vpp)

AUDIO OUTPUT: -5V to +5V (10V peak to peak)

ROW TWO



BLEND

This CV input is for the **BLEND** crossfader. It sums with the **BLEND** panel control.

CV INPUT: -5V to +5V

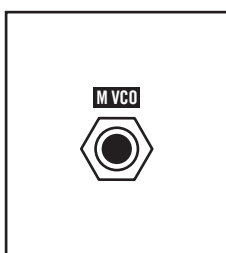

M VCO

Output for the **MOD VCO**

AUDIO/CV OUTPUT: -5V to +5V

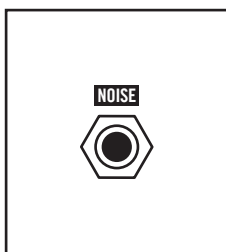

NOISE

Audio output for the variable-tone **NOISE** generator

AUDIO OUTPUT: -5V to +5V

PATCH BAY *(Continued)*



MIXER

Audio output from the **MIXER**

AUDIO OUTPUT: -5V to +5V

ROW THREE

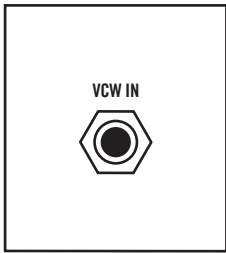

VCW IN

Audio input to the **VCW** section

AUDIO INPUT: -5V to +5V

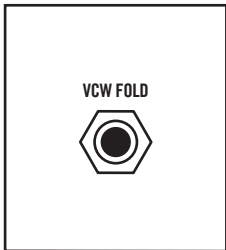

VCW FOLD

This is the CV input for **VCW FOLD**. A positive CV input increases the depth of wavefolding. It is summed with the **VCW FOLD** panel control. **EG1** is normalled to the input of this jack; patching an external CV will break the normalled connection. The **EG1/CV AMT** knob attenuates incoming CV.

CV INPUT: -5V to +5V

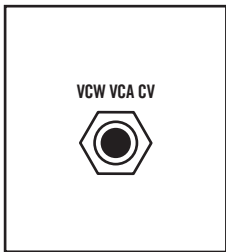

VCW VCA CV

This is the CV input that controls the level of the Voltage-Controlled Amplifier (VCA) for the VCW section. **EG2** is normalled to the input of this jack; patching a signal to **VCW VCA CV** will break that normalled connection.

CV INPUT: 0V to +8V

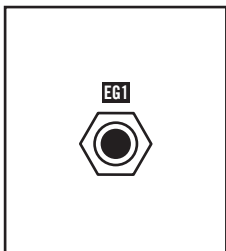

EG1

CV output for EG1

CV OUTPUT: 0V to +8V

PATCH BAY *(Continued)*

ROW FOUR

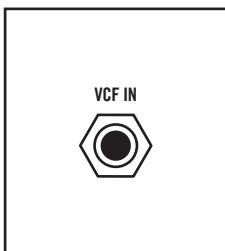

VCF IN

Audio input to the VCF section

AUDIO INPUT: -5V to +5V

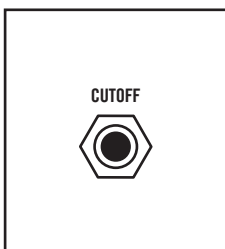

CUTOFF

This is the CV input for the filter CUTOFF. A positive CV input increases the cutoff frequency of the **VCF**. It is summed with **VCF CUTOFF** panel control. **EG1** is normalled to the input of this jack; patching an external CV will break that normalled connection. The **EG1/CV AMT** knob attenuates incoming CV.

CV INPUT: -5V to +5V

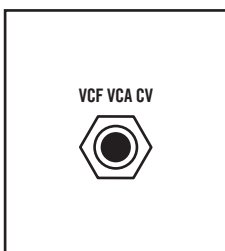

VCF VCA CV

This is the CV input that controls the level of the Voltage-Controlled Amplifier (VCA) for the VCF section. **EG2** is normalled to the input of this jack; patching a signal to **VCF VCA CV** will break that normalled connection.

CV INPUT: 0V to +8V

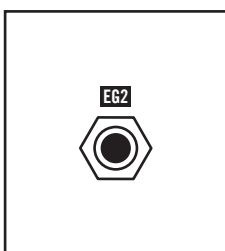

EG2

CV output for EG2

CV OUTPUT: 0V to +8V

ROW FIVE



U MIX 1 (RING)

This is the input for channel 1 of the **U MIX** mixer. It is DC coupled so that it can accept either audio or control signals. Its level is controlled by the **U MIX 1 LVL** panel control. The **RING MOD** between the **VCO** and **MOD VCO** is normalled to the input of this jack; patching a signal to **U MIX 1 (RING)** will break that normalled connection.

AUDIO INPUT: -5V to +5V

PATCH BAY *(Continued)*

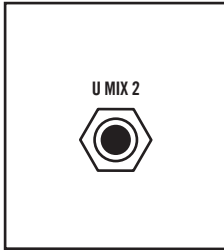

U MIX 2

This is the input for channel 2 of the U MIX mixer. It is DC coupled so that it can accept either audio or control signals. **U MIX 2** passes signal to the **U MIX 1+2** output at unity gain.

AUDIO INPUT: -5V to +5V



U MIX 1+2

This is the output of the **U MIX** mixer. It mixes the signal at **U MIX 2** with the signal at **U MIX 1**. The level of channel 1 is set by **U MIX 1 LVL** panel control.

AUDIO OUTPUT: -5V to +5V

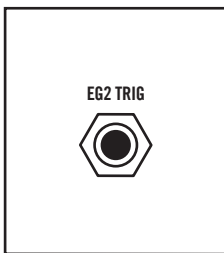

EG2 TRIG

CV input to trigger EG2 (rising edge triggers envelope)

CV INPUT: 0V to +10V

ROW SIX

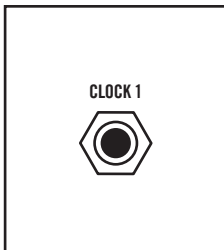

CLOCK 1

This is the clock input for **SEQ1**. The internal **CLOCK** set by **TEMPO** (or MIDI **CLOCK** when present) is normalled to the input of this jack.

CV INPUT: 0V to +10V

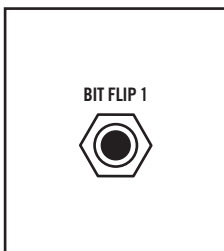

BIT FLIP 1

This is the digital input for **SEQ1**. It flips the state of the current bit located at the write head if input is high.

CV INPUT: 0V to +10V

PATCH BAY *(Continued)*

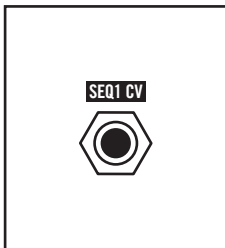

SEQ1 CV

This is the CV output for **SEQ1**. It outputs CV voltage stored at the current bit located at the play head—scaled by the **SEQ 1 CV RANGE** control and quantized by the internal quantizer.

CV OUTPUT: -5V to +5V



SEQ1 TRIG

This is the trigger output from **SEQ1**. It produces a trigger when play head moves to a bit that is set to on.

CV OUTPUT: 0V to +5V

ROW SEVEN

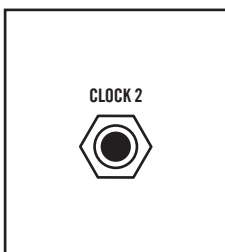

CLOCK 2

This is the clock input for **SEQ2**. The input to the **CLOCK 1** jack is normalled to the input of this jack.

CV INPUT: 0V to +10V

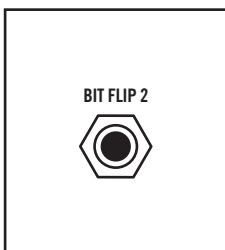

BIT FLIP 2

This is the digital input for **SEQ2**. It flips the state of the current bit located at the write head if input is high.

CV INPUT: 0V to +10V



SEQ2 CV

This is the CV output for **SEQ2**. It outputs CV voltage stored at the current bit located at the play head—scaled by the **SEQ 2 CV RANGE** control and quantized by the internal quantizer.

CV OUTPUT: -5V to +5V

PATCH BAY *(Continued)*



SEQ2 TRIG

This is the trigger output from **SEQ2**. It produces a trigger when the play head moves to a bit that is set to on.

CV OUTPUT: 0V to +5V

ROW EIGHT

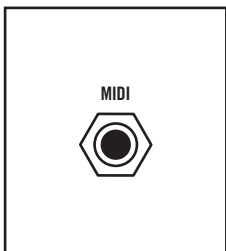

MIDI

This is a 3.5mm MIDI RX input. MIDI responds to Clock, Note On, and Start/Stop/Continue messages. Any MIDI clock activity automatically switches Labyrinth's clock to MIDI mode until a 5-second timeout period has elapsed with no additional MIDI messages.

MIDI INPUT: MIDI Data

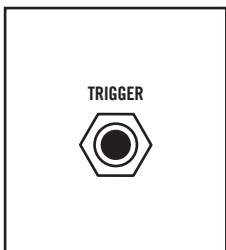

TRIGGER

This CV input triggers both envelope generators (**EG1** and **EG2**). The rising edge triggers the envelope. A gate or trigger patched to **TRIGGER** will trigger both envelopes, but if the **EG2 TRIG** input has been patched, the **TRIGGER** input will only trigger **EG1**.

CV INPUT: 0V to +10V

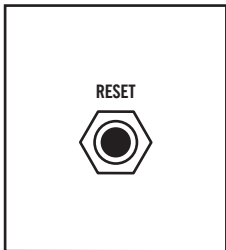

RESET

The rising edge resets play head to step 1. If write head is offset from the play head (via **BIT SHIFT + ADVANCE** command), then the write head will remain offset relative to the play head and will not reset to bit 1.

CV INPUT: 0V to +10V

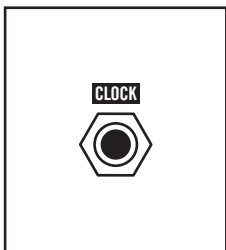

CLOCK

This is the clock output for Labyrinth's internal clock set by **TEMPO**. It outputs MIDI clock if present.

CV OUTPUT: 0V to +5V

■ GLOBAL SETTINGS

By holding **BUFFER + RESET** while Labyrinth is booting up, users can enter a Global Settings Mode. Only two Global Settings exist which are indicated by a corresponding LED in the BITS section.

By pressing **LENGTH** (1) (-) and **BIT FLIP** (1) (+), users may select a setting. The currently selected setting will pulse at a slow rate.

By pressing **BIT SHIFT** (1) and **BIT SHIFT** (2), users may change the value of the currently selected setting. The color of the LED indicates its value. See the table below for what the colors mean for each setting. In all cases, red is the default value.

By pressing **BUFFER**, users may save the currently selected settings and return to normal operation. All LEDs will flash green three times to indicate a successful save.

Setting (SEQ, Bit)	Description	RED Setting	GREEN Setting
1, 1	RESET IN jack behavior	+5 Volts at RESET IN Jack resets sequencer to bit 1	+5 Volts at RESET IN Jack resets sequencer to bit 1 AND recalls the Buffer
1, 2	CV Out Polarity	Bipolar: CV Outs generate voltages between +/- 5V centered at 0V	Unipolar: CV Outs generate voltages between 0V → +5V centered at 0V

■ MIDI OPERATIONS

When a MIDI clock pulse is received, Labyrinth’s master clock automatically switches over to MIDI clock with division based on the MIDI Clock Div setting. If a MIDI clock pulse is not received for five seconds, Labyrinth’s master clock reverts to the internal clock. External clocks patched into **CLOCK1,2** will override the MIDI clock.

MIDI Message	Behavior
MIDI Note On	<p>If the quantizer is on (i.e., if quantizer is set to any scale other than “Unquantized”), a MIDI Note On message will transpose the root of SEQ1 & SEQ2 quantized CVs to new MIDI note.</p> <p>In addition, if the sequencers are <i>not</i> running, a MIDI Note On message will generate a trigger, allowing Labyrinth to be played like a keyboard instrument.</p>
MIDI Clock Pulse	This drives MIDI clock dividers, assuming 24 PPQN.
MIDI Start	This resets sequencers and begins playing sequencers if they’re not already running.
MIDI Stop	If sequencers are running, this stops the sequencers.
MIDI Continue	If sequencers are not already running, this starts sequencers. It does <i>not</i> reset sequencers.
MIDI Song Position 0:00	This resets sequencers and only reacts to a song position time of 0; all other song position messages are ignored.

PRESETS

Labyrinth is a semi-modular analog instrument and therefore does not contain any presets. The settings on the panel, patch connections made, and state of its randomized, generative sequencer will all determine how it functions at any given time. Use the following patch ideas as jumping-off points to explore the world of parallel voice processing, experiment with generative sequencing, and interface Labyrinth with external instruments. More presets, tips, and tricks for this synthesizer can be found at www.moogmusic.com/explore-labyrinth.

A SIMPLE START

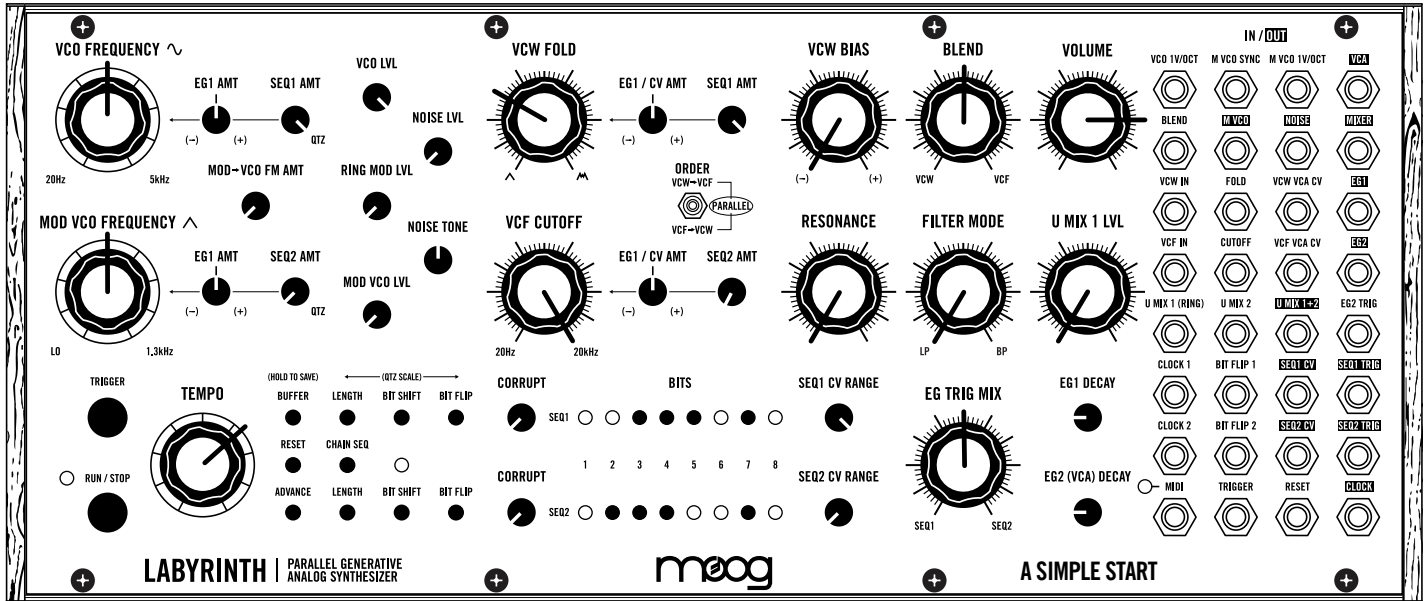

NOTES:

Set quantize mode to #13 Minor 7th Scale.
 Set bit flips for **SEQ1** 3, 4, 5, 7; set bit flips for **SEQ2** 2, 3, 4, 5, 7.
 Slightly adjust **MOD→VCO FM AMT** for vibrato, and adjust **MOD VCO FREQUENCY** for speed.

LOST IN THE LABYRINTH

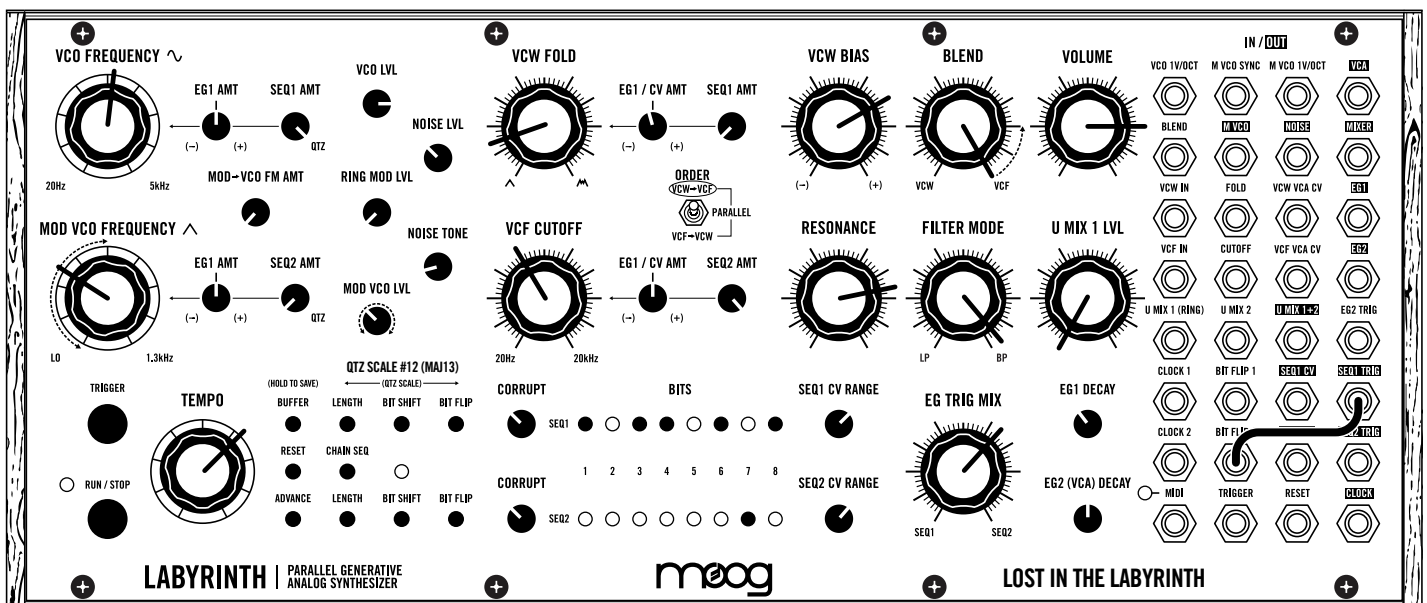

NOTES:

Adjust **MOD VCO FREQUENCY** and **MOD VCO LVL** for more metallic tones.

DRY BRUSHES

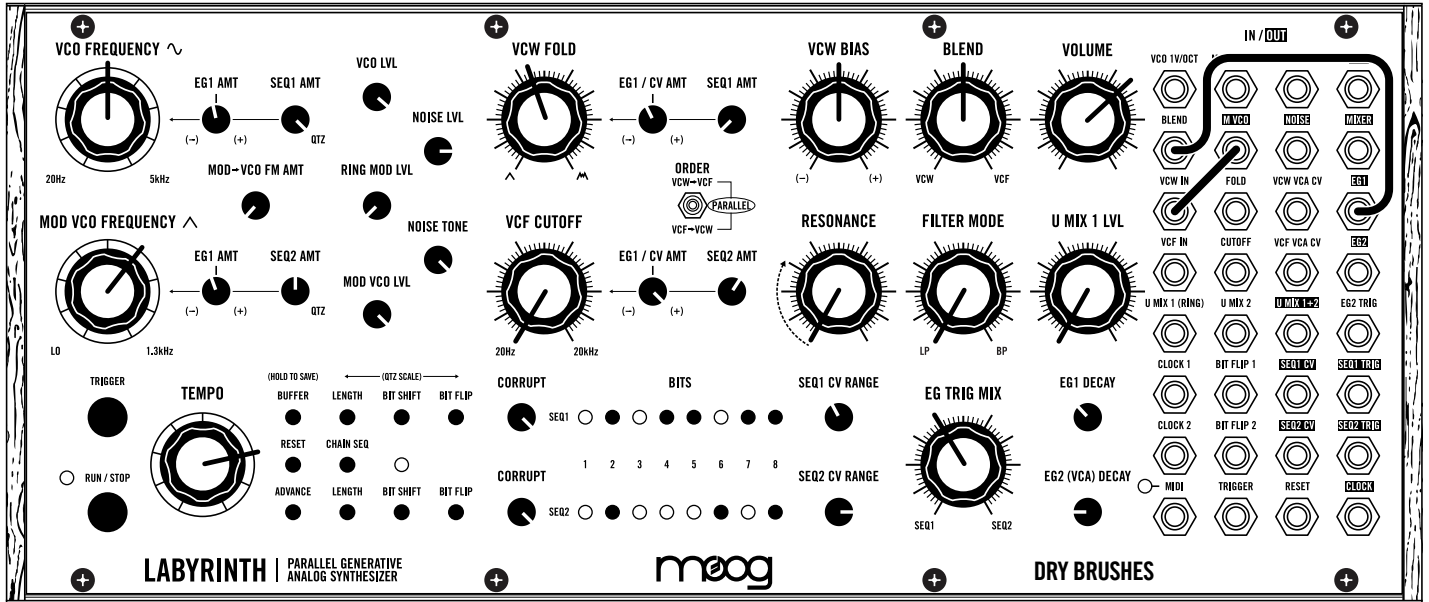

NOTES:

- Set quantize mode to #13 Minor 7th Scale.
- Experiment with changing amount of steps in each row.
- Momentarily link sequences for dynamic “percussion fills.”
- Adjust **MOD VCO FREQUENCY** below 10 o'clock for harmonic content.

CELESTIAL CONVERSATIONS

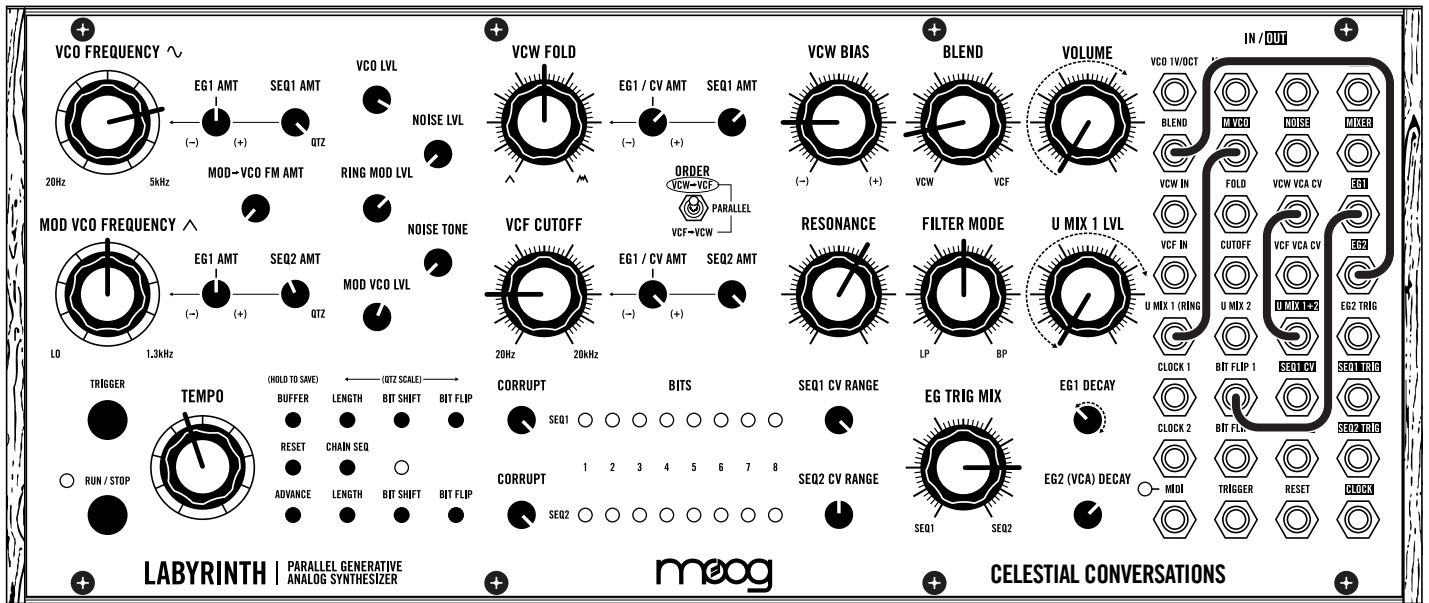

NOTES:

- Set quantize mode to #15 Hang Drum tuning.
- As sequence plays, slowly bring **U MIX 1 LVL** knob up for second timbre.
- MOD VCO FREQUENCY** will control speed/rate of second timbre.
- Adjust **EG1 DECAY** for added chorus-like textures.

SPIRAL ENIGMA

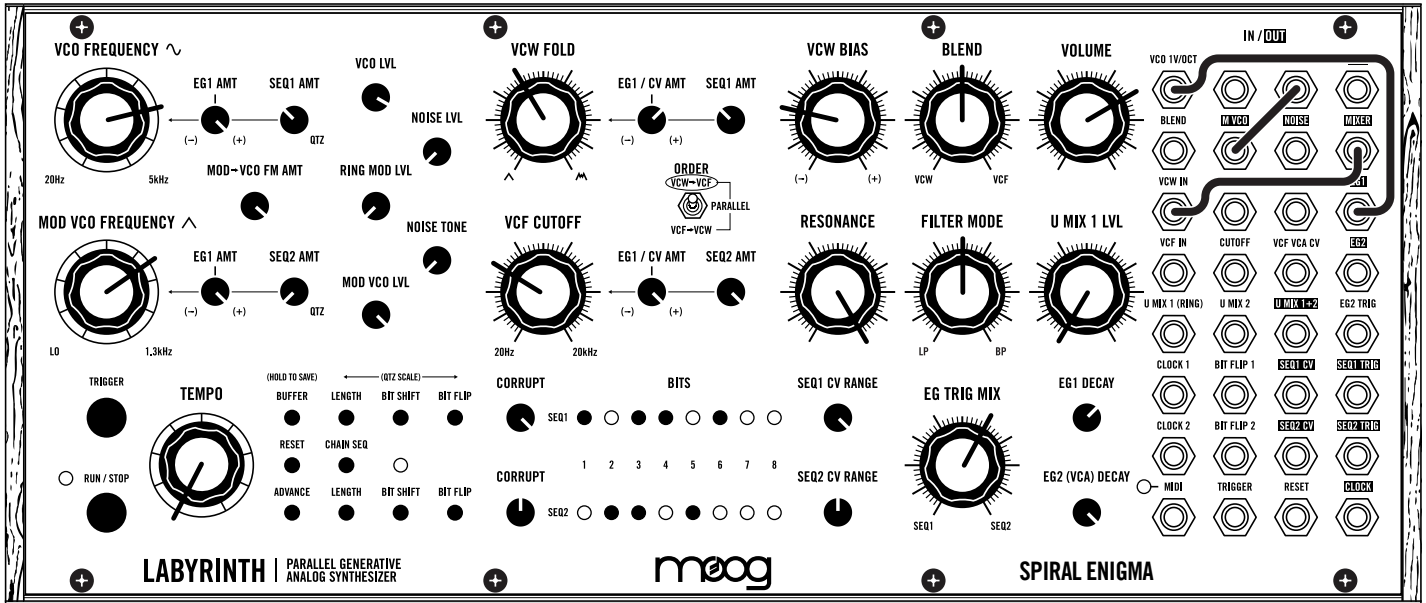

NOTES:

Set quantize mode to #1 Unquantized.

Slowest tempo yields maximum animation, and adjust **EG DECAY** for variations.

Adjust **VCO FREQUENCY** for variations, and adjust **MOD VCO** for frequency modulation.

Tip: Experiment with different sequence length for interesting animations.

Tip: Patch a sequence or audio rate modulation from an external source to create haunting and interwoven “crosstalk” as Labyrinth cycles through its sequence. Patch into **FOLD VCA CV**.

SWIRLING MAGENTA

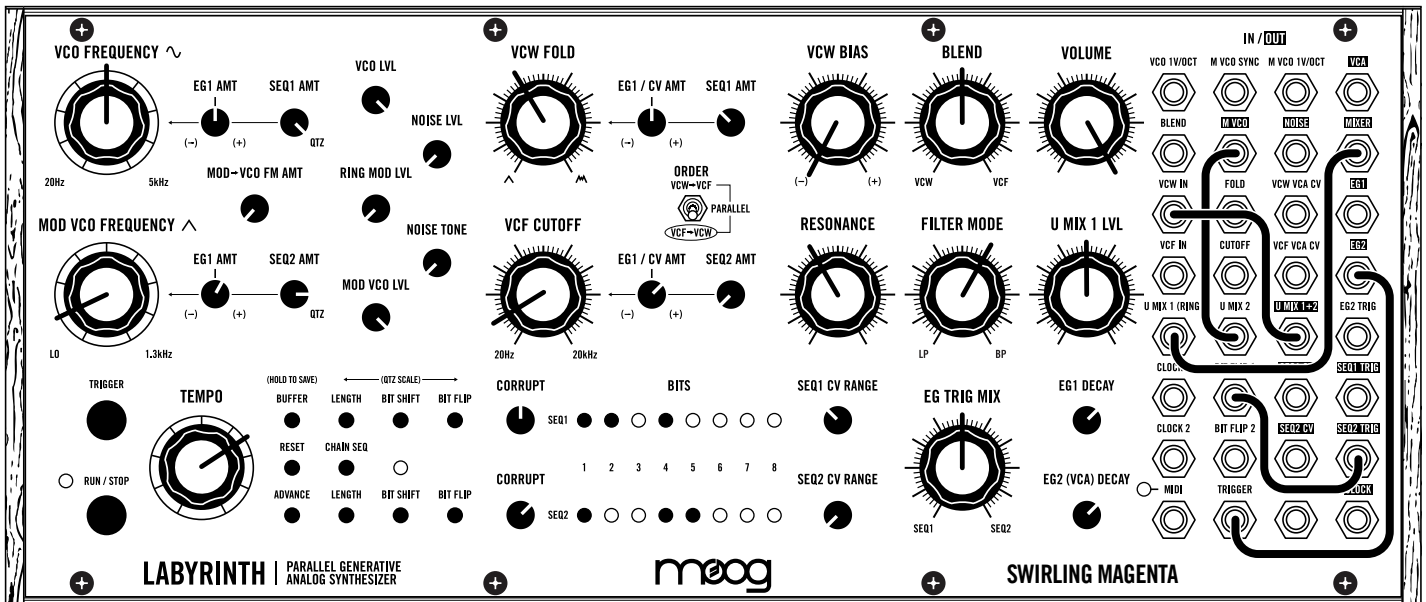

NOTES:

Set quantize mode to #9 Hirajoshi Pentatonic.

Adjust **U MIX LVL** for a variety of different tones and colors, and adjust **VCW BIAS** for tone.

Tip: Patch trigger out into **VCO 1V/OCT** for a metallic hi-hat, and adjust **MOD VCO** for phaser speed.

Tip: Turn **CORRUPT** to full on **SEQ 1 & 2** - Dial **EG DECAY 1 & 2** back to a short percussive decay.

NEW FRONTIERS

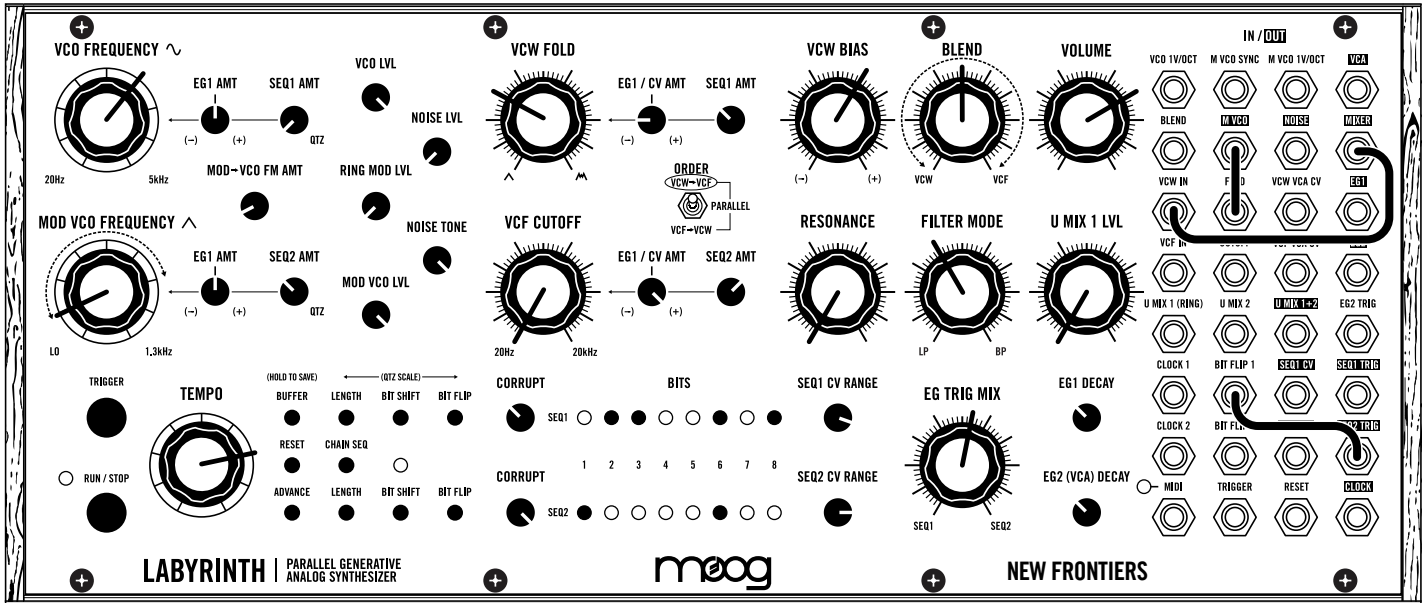

NOTES:

Set quantize mode to #4 Pentatonic.

Adjust **BLEND** for timbre volumes.

Adjust **MOD VCO FREQUENCY** for frequency modulation.

Tip: Patch keyboard CV AMT from an external source to **VCO 1V/OCT** to transpose sequence.

SYNDRUMS

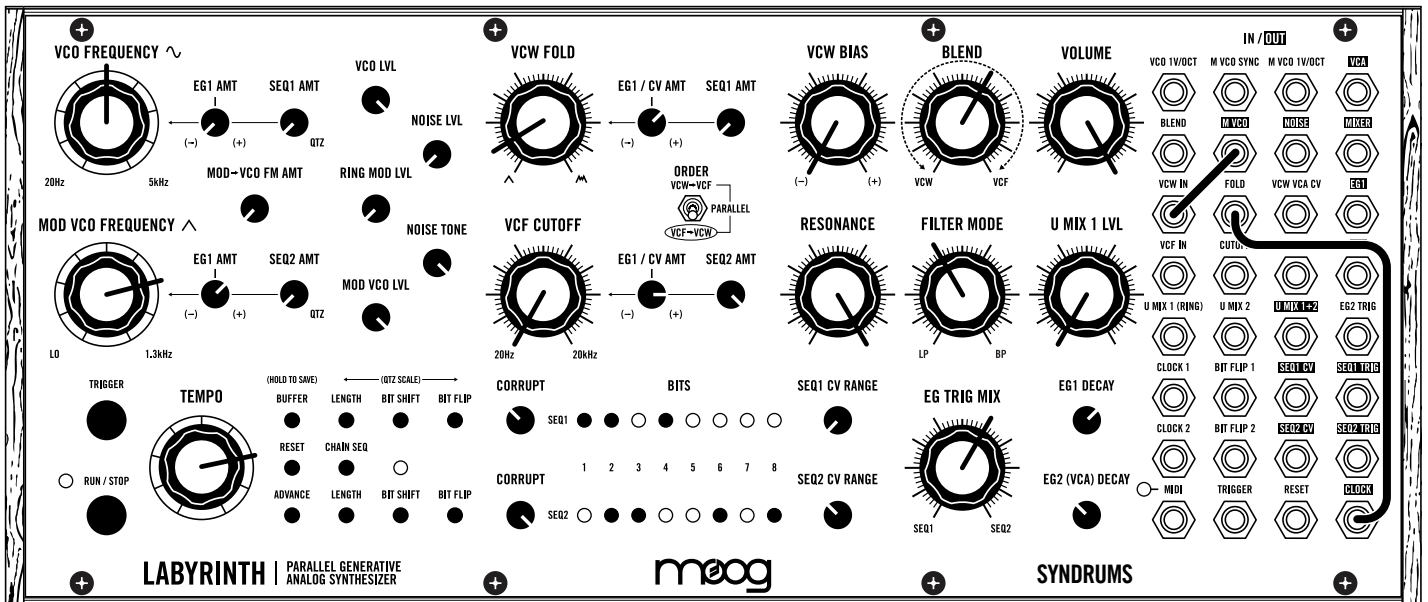

NOTES:

Adjust blend for drum mixing.

Increase corrupt on **SEQ 1** for variations.

Tip: Patch **EG2** to **BIT FLIP 1** for extensive rhythmic variations.

TELEMECHANICAL BIRDS

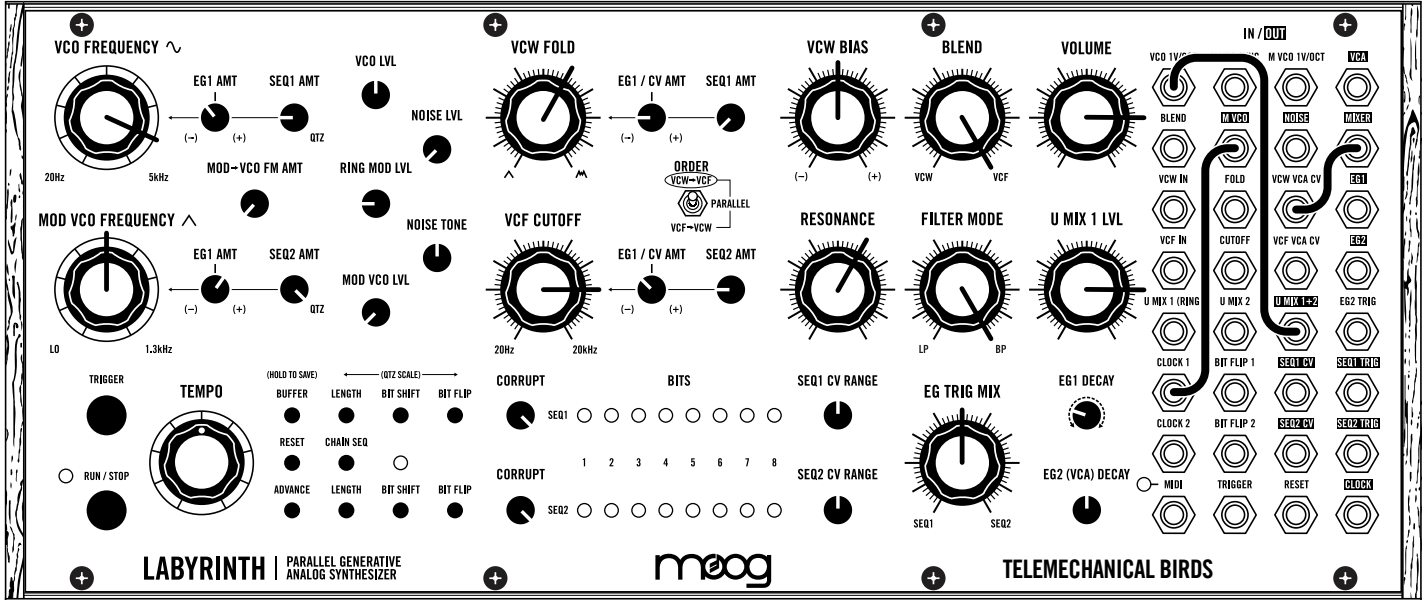

NOTES:

Play with **EG1 DECAY** for more or less artificial bird noise.

WHERE YOU LEAD KICKS FOLLOW

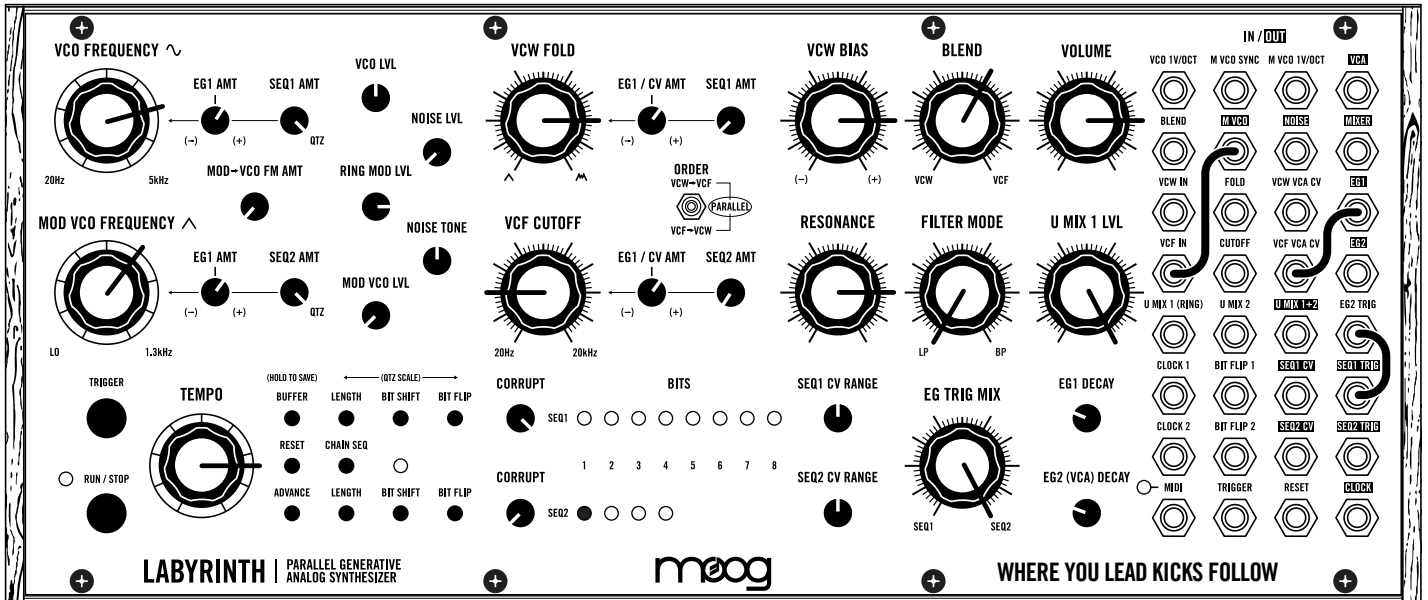

NOTES:

EG1 DECAY controls kick drum decay time.

EG2 DECAY controls lead synth decay time.

TWINKLE TOES

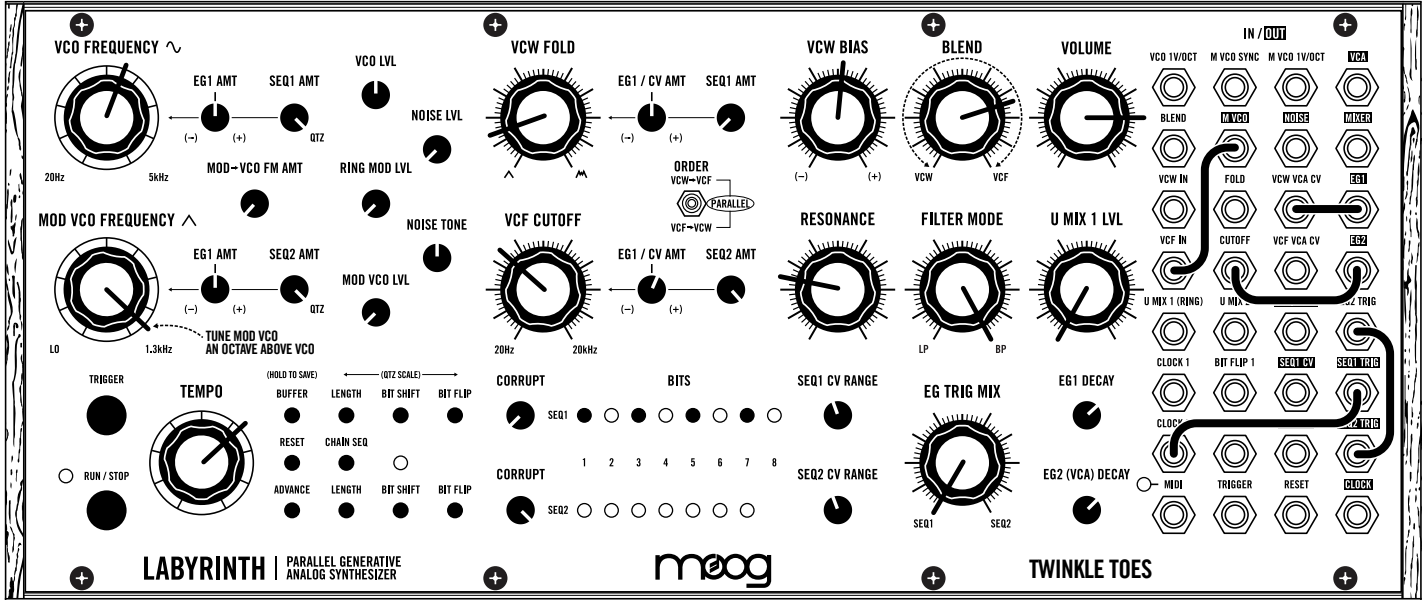

NOTES:

Adjust **SEQ1**, **SEQ2 CV RANGE** knobs to scale each respective voice's sequence.

Adjust **BLEND** to emphasize one voice over the other.

Tip: experiment with different quantizer scales.

THE OOZE

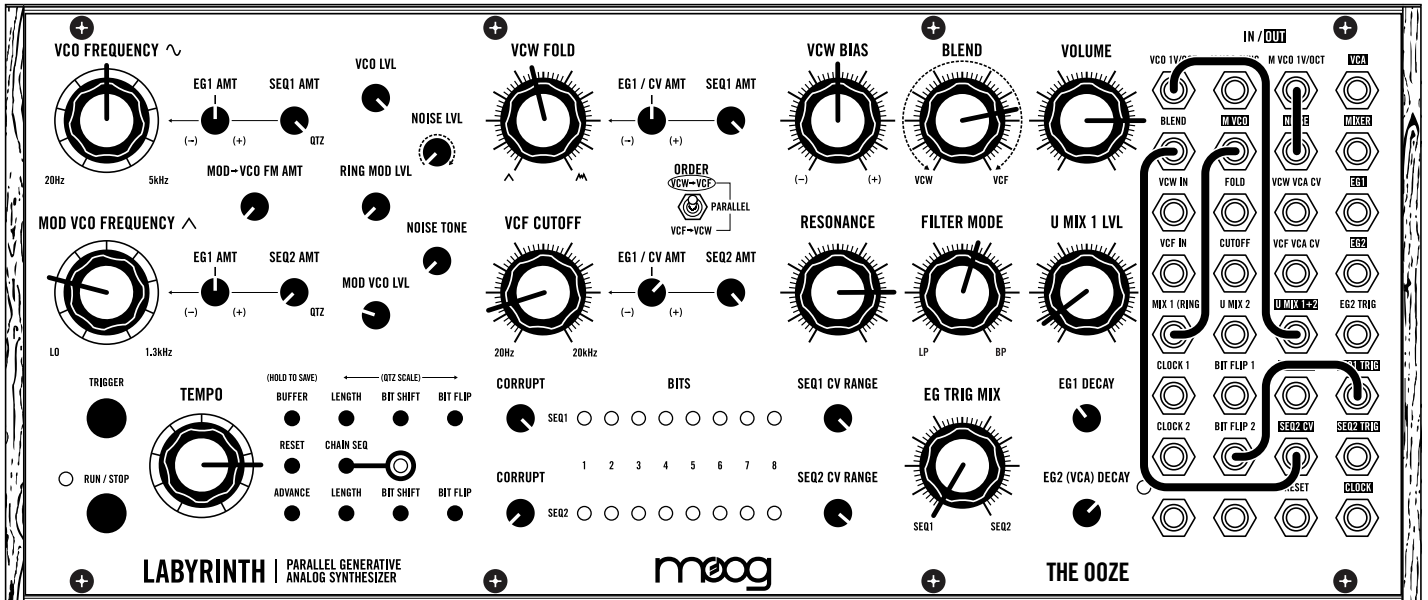

NOTES:

UMIX LVL controls the depth of ooze.

Press **SEQ2 BIT SHIFT** to explore different generative relationships between sequences.

Adjust **NOISE LVL** to add instability.

Experiment with different quantizer scales.

PRESET NAME:

LABYRINTH | PARALLEL GENERATIVE ANALOG SYNTHESIZER

moog

NOTES:

PRESET NAME:

LABYRINTH | PARALLEL GENERATIVE ANALOG SYNTHESIZER

moog

NOTES:

PRESET NAME:

NOTES:

PRESET NAME:

NOTES:

PRESET NAME:

NOTES:

PRESET NAME:

NOTES:

PRESET NAME:

NOTES:

PRESET NAME:

NOTES:

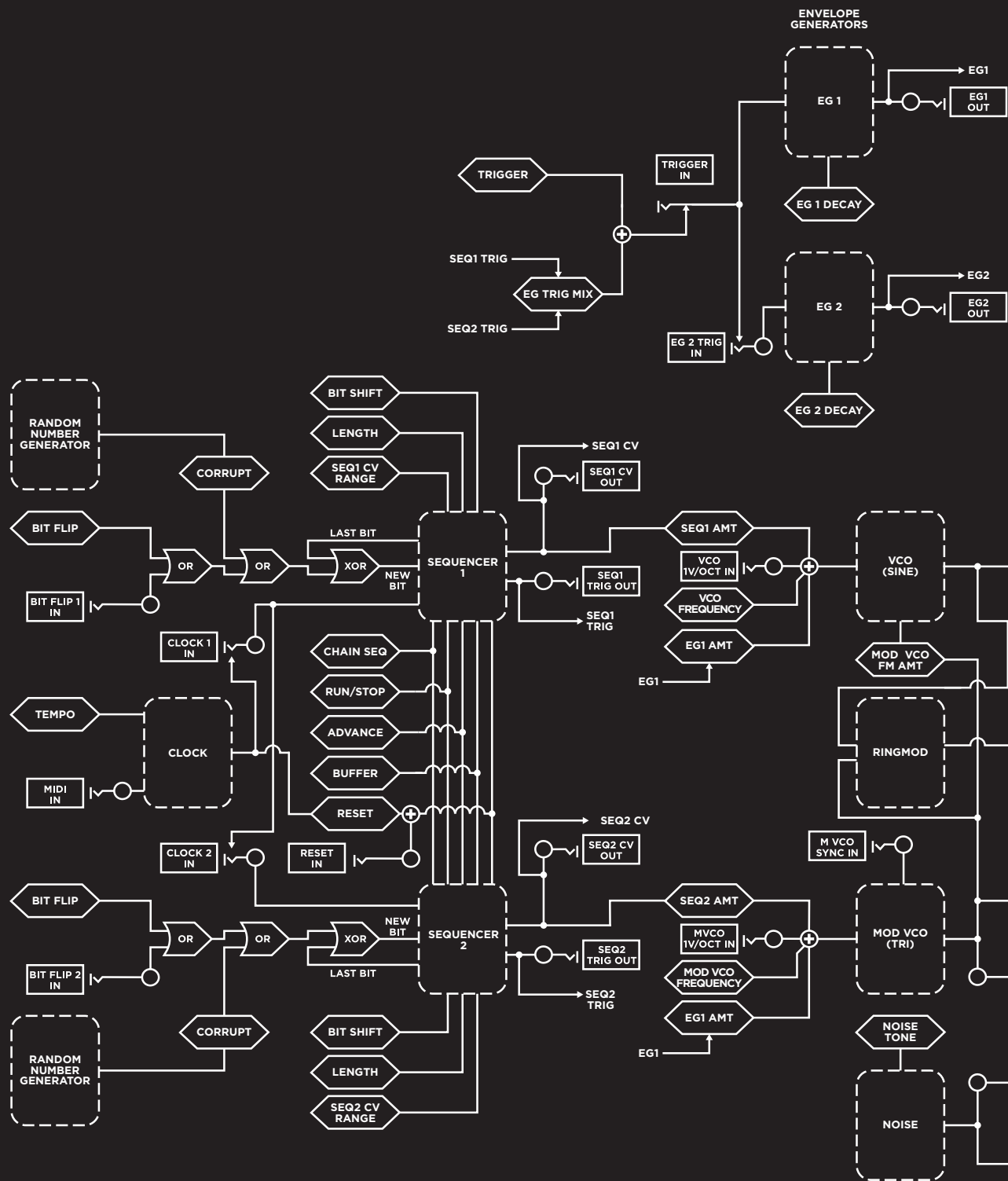

SIGNAL FLOW

UTILITY

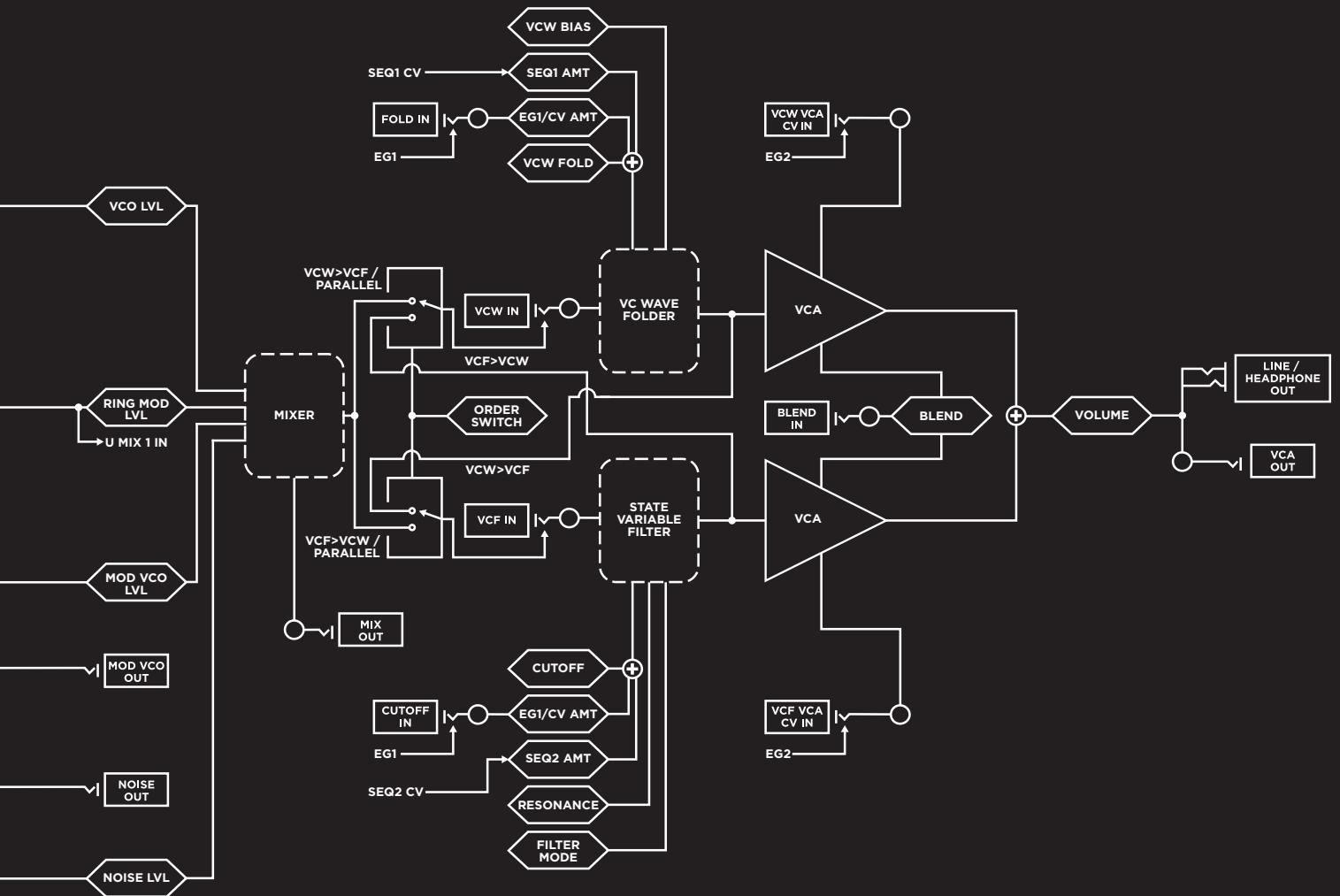
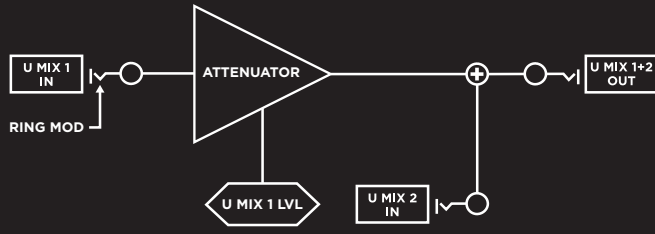

KEY

	FRONT PANEL CONTROL		NOT CONNECTED		JACK
	MODULE		CONNECTION		NORMALISED JACK
	AMPLIFIER		SUMMING		MODE

■ SPECIFICATIONS

ANALOG SYNTHESIS ENGINE

SOURCES: VCO, MOD VCO, RING MOD, NOISE Generator

SIGNAL PROCESSORS: 1x Voltage-Controlled Wavefolder, 1x Voltage-Controlled State-Variable Filter, 2x Voltage-Controlled Amplifiers

MODULATORS: 2x Decay-only envelope generators

DUAL GENERATIVE SEQUENCER

2x 8-step Generative Digital Sequencers

PATCH BAY

JACKS: 32 x 3.5mm

INPUTS: 20 Input Jacks

OUTPUTS: 12 Output Jacks

REAR PANEL

AUDIO: 1/4" TRS Headphone or 1/4" TS Instrument

POWER: Power Supply connection

SECURITY: Kensington Lock slot

DIMENSIONS

SIZE (WxDxH): 12.57" x 4.21" x 5.24"

WEIGHT: 3.2 lbs

POWER SUPPLY (INCLUDED)

STYLE: Wall adapter; barrel connection; center-pin positive

INPUT: 100 - 240VAC; 50 Hz - 60 Hz

OUTPUT: +12VDC; 1200mA

POWER CONSUMPTION

TYPICAL: 4.0 watts

EURORACK SPECS

CURRENT DRAW: 290 mA (maximum) from +12VDC (10-pin header)

MOUNTING DIMS: 60HP (18mm Module Depth)

ACCESSORIES

The following accessories are available for purchase at authorized Moog dealers and select offerings at www.moogmusic.com:

KNOB KIT FOR KNURLED POTS (QTY 25)

2-TIER VERTICAL RACK KIT

3-TIER VERTICAL RACK KIT

4-TIER VERTICAL RACK KIT

6" 3.5 mm CABLE PACK (QTY 5)

12" 3.5 mm CABLE PACK (QTY 5)

104-HP POWERED EURORACK CASE

BACKUP POWER SUPPLY

■ SERVICE & SUPPORT INFORMATION

MOOG'S STANDARD WARRANTY

Moog warrants its products to be free of defects in materials or workmanship and conforming to specifications at the time of shipment. The Warranty Period is one year from the date of purchase. If, in Moog's determination, it has been more than five years since the product shipped from our factory, it will be at Moog's discretion whether or not to honor the warranty without regard to the date of the purchase. During the Warranty Period, any defective products will be repaired or replaced, at Moog's option, on a return-to-factory basis. This warranty covers defects that Moog determines are no fault of the user.

The Moog Limited Warranty applies to USA purchasers only. Outside the USA the warranty policy and associated service is determined by the laws of the country of purchase and supported by our local authorized distributor. A listing of our authorized distributors is available at www.moogmusic.com.

If you purchase outside of your country, you can expect to be charged for warranty as well as non-warranty service by the service center in your country.

RETURNING YOUR PRODUCT TO MOOG MUSIC

You must obtain prior approval in the form of an RMA (Return Material Authorization) number from Moog before returning any product. Email techsupport@moogmusic.com for the RMA number or call us at +1 (828) 251-0090. All products must be packed carefully and shipped with the Moog supplied power adapter. Labyrinth must be returned in the original inner packing including the cardboard inserts. The warranty will not be honored if the product is not properly packed. Once you have received the RMA number and carefully packed your Moog Labyrinth, ship the product to Moog Music, Inc. with transportation and insurance charges paid, and be sure to include your return shipping address.

MOOG MUSIC, INC.
160 Broadway St.
Asheville, NC 28801

WHAT WE WILL DO

Once received, we will examine the product for any obvious signs of user abuse or damage as a result of transport. If the product was abused, was damaged in transit, or is out of warranty, we will contact you with an estimate of the repair cost. If warranty work is performed, Moog will ship and insure your product to your United States address free of charge.

HOW TO INITIATE YOUR WARRANTY

Please initiate your warranty online at www.moogmusic.com/register. If you do not have web access, please call (828) 251-0090 to register your product.

CARING FOR LABYRINTH

Clean Labyrinth with a soft, dry cloth only—do not use solvents or abrasive detergents. Heed the safety warnings at the beginning of the manual. Do not drop the unit.

AN IMPORTANT NOTE ABOUT SAFETY: *There are no user serviceable parts in Labyrinth. Refer all servicing to qualified personnel only.*

©2023 Moog Music, Inc. All rights reserved. Moog, Moog (stylized with design), and the Moog logo are trademarks of Moog Music, Inc. Registered in U.S. Patent and Trademark Office and elsewhere. Labyrinth is a trademark of Moog Music, Inc. Registered in the United States and elsewhere.

Phone: +1 (828) 251-0090 | Email: info@moogmusic.com | Website: www.moogmusic.com

